

# VGN-T52B/T72B/T72PZ/T92PS/T92PSY/T92S VGN-T330FP/T340P/T350/T350P/T360P/T370P VGN-T36SP/T37C/T37GP/T37TP

## SERVICE MANUAL

Ver. 4 2005G

### Revision History

| Area        | Model       | Lineup                         |               |             |        |
|-------------|-------------|--------------------------------|---------------|-------------|--------|
| Japanese    | Japanese    | VGN-T52B/L                     | ⚠ [MA]        |             |        |
|             |             | VGN-T72B/L                     |               |             |        |
|             |             | VGN-T72B/T                     |               |             |        |
|             |             | VGN-T72PZ                      |               |             |        |
|             |             | VGN-T92PS*                     |               |             |        |
|             |             | VGN-T92PSY*                    |               |             |        |
|             |             | VGN-T92S*                      |               |             |        |
| American    | US Canadian | VGN-T340P/L                    | ⚠ [MA]        |             |        |
|             |             | VGN-T350/L                     | ⚠ [MA]        |             |        |
|             |             | VGN-T350P/L                    | ⚠ [MA]        |             |        |
|             |             | VGN-T350P/S                    | ⚠ [MA]        |             |        |
|             |             | VGN-T350P/T                    | ⚠ [MA]        |             |        |
|             |             | VGN-T360P/L                    | ⚠ [MA]        |             |        |
|             |             | VGN-T370P/L                    | ⚠ [MA]        |             |        |
|             | Latin       | VGN-T330FP/L                   | ⚠ [MA]        |             |        |
|             |             | VGN-T330FP/T                   | ⚠ [MA]        |             |        |
|             |             | Asian/Oceania/<br>South Africa | International | VGN-T36SP/S | ⚠ [MA] |
|             |             |                                |               | VGN-T37GP/L | ⚠ [MA] |
| VGN-T37GP/S | ⚠ [MA]      |                                |               |             |        |
|             | VGN-T37TP/L | ⚠ [MA]                         |               |             |        |
|             | VGN-T37TP/S | ⚠ [MA]                         |               |             |        |
|             | Chinese     | VGN-T37C/L                     | ⚠ [MA]        |             |        |

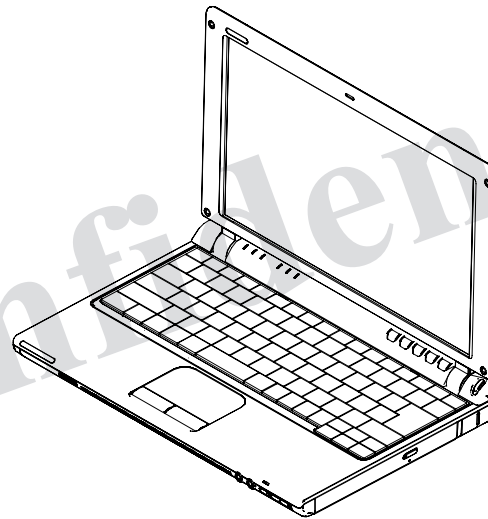

· Design and specifications are subject to change without notice.

· 本機の仕様および外観は、改良のため予告なく変更することがありますが、ご了承ください。

## PERSONAL COMPUTER

# SONY®

Information in this document is subject to change without notice.

Sony, VAIO and CLIE are trademarks or registered trademarks of Sony. Microsoft, Windows, Windows Media, Outlook, Bookshelf and other Microsoft products are trademarks or registered trademarks of Microsoft Corporation in the United States and other countries. The word Bluetooth and the Bluetooth logo are trademarks of Bluetooth SIG, Inc. AMD, AMD logo, AMD Duron and combinations there of, 3DNow!, are trademarks of Advanced Micro Devices, Inc. Intel Inside logo, Pentium and Celeron are trademarks or registered trademarks of Intel Corporation. Transmeta, the Transmeta logo, Crusoe Processor, the Crusoe logo and combinations there of are trademarks of Transmeta Corporation in the USA and other countries. Graffiti, HotSync, PalmModem, and Palm OS are registered trademarks, and the Hotsync logo and Palm are trademarks of Palm, Inc. or its subsidiaries. (M) and Motorola are trademarks of Motorola, Inc. Other Motorola products and services with (R) mark like Dragomball are the trademarks of Motorola, Inc.

All other names of systems, products and services in this manual are trademarks or registered trademarks of their respective owners. In this manual, the (TM) or (R) mark are not specified.

**CAUTION – CLASS 3B VISIBLE AND INVISIBLE LASER RADIATION WHEN OPEN. AVOID EXPOSURE TO THE BEAM.**

Caution Markings for Lithium/Ion Battery - The following or similar texts shall be provided on battery pack of equipment or in both the operating and the service instructions.

CAUTION: Danger of explosion if battery is incorrectly replaced. Replace only with the same or equivalent type recommended by the manufacturer. Discard used batteries according to the manufacturer's instructions.

CAUTION: The battery pack used in this device may present a fire or chemical burn hazard if mistreated. Do not disassemble, heat above 100°C (212°F) or incinerate. Dispose of used battery promptly. Keep away from children.

CAUTION: Changing the back up battery.

- Overcharging, short circuiting, reverse charging, multilati on or incineration of the cells must be avoided to prevent one or more of the following occurrences; release of toxic materials, release of hydrogen and/or oxygen gas, rise in surface temperature.
- If a cell has leaked or vented, it should be replaced immediately while avoiding to touch it without any protection.

## Service and Inspection Precautions

### 1. Obey precautionary markings and instructions

Labels and stamps on the cabinet, chassis, and components identify are as requiring special precautions. Be sure to observe these precautions, as well as all precautions listed in the operating manual and other associated documents.

### 2. Use designated parts only

The set's components possess important safety characteristics, such as noncombustibility and the ability to tolerate large voltages. Be sure that replacement parts possess the same safety characteristics as the originals. Also remember that the  $\Delta$  mark, which appears in circuit diagrams and parts lists, denotes components that have particularly important safety functions; be extra sure to use only the designated components.

### 3. Always follow the original design when mounting parts and routing wires

The original layout includes various safety features, such as inclusion of insulating materials (tubes and tape) and the mounting of parts above the printer board. In addition, internal wiring has been routed and clamped so as to keep it away from hot or high-voltage parts. When mounting parts or routing wires, therefore, be sure to duplicate the original layout.

### 4. Inspect after completing service

After servicing, inspect to make sure that all screws, components, and wiring have been returned to their original condition. Also check the area around the repair location to ensure that repair work has caused no damage, and confirm safety.

### 5. When replacing chip components...

Never reuse components. Also remember that the negative side of tantalum capacitors is easily damaged by heat.

### 6. When handling flexible print boards...

- The temperature of the soldering-iron tip should be about 270°C.
- Do not apply the tip more than three times to the same pattern.
- Handle patterns with care; never apply force.

Caution: Remember that hard disk drives are easily damaged by vibration. Always handle with care.

#### ATTENTION AU COMPOSANT AYANT RAPPORT À LA SÉCURITÉ!

LES COMPOSANTS IDENTIFIÉS PAR UNE MARQUE  $\Delta$  SUR LES DIAGRAMMES SCHÉMATIQUES ET LA LISTE DES PIÈCES SONT CRITIQUES POUR LA SÉCURITÉ DE FONCTIONNEMENT. NE REMPLACER CES COMPOSANTS QUE PAR DES PIÈCES SONY DONT LES NUMÉROS SONT DONNÉS DANS CE MANUEL OU DANS LES SUPPLÉMENTS PUBLIÉS PAR SONY.

**Confidential**

VGN-T52B/T72B/T72PZ/T92PS/T92PSY/T92S (J)  
VGN-T330FP/T340P/T350/T350P/T360P/T370P (AM)  
VGN-T36SP/T37C/T37GP/T37TP (AO)

## TABLE OF CONTENTS

| <u>Section</u>                                  | <u>Title</u>  | <u>Page</u>       | <u>Section</u>           | <u>Title</u>                             | <u>Page</u>     |
|---|---|-------------------|--------------------------|--|-----------------|
| <b>CHAPTER 1. SPECIFICATIONS</b>                |   |                   | <b>CHAPTER 5. OTHERS</b> |  |                 |
| 1-1.  | Specifications .....                                      | 1-1<br>(to 1-2)   | 5-1.                     | The Barcode Label .....                  | 5-1             |
| <b>CHAPTER 2. BLOCK DIAGRAM</b> .....           |   |                   | 5-2.                     | Precautions for Handling the Drive ..... | 5-2             |
|   |   |                   | 5-3.                     | Note for WWAN Board Replacement .....    | 5-3<br>(to 5-3) |
| <b>CHAPTER 3. FRAME HARNESS DIAGRAM</b> .....   |   |                   |                          |  |                 |
|   |   |                   |                          |  |                 |
| <b>CHAPTER 4. EXPLODED VIEWS AND PARTS LIST</b> |   |                   |                          |  |                 |
|   | How to identify the VGN-T92PSY .....                      | 4-2               |                          |  |                 |
|   | Palmrest  |                   |                          |  |                 |
|   | P-1 .....   | 4-3               |                          |  |                 |
|   | Main Board  |                   |                          |  |                 |
|   | M-1 .....   | 4-5               |                          |  |                 |
|   | Bottom  |                   |                          |  |                 |
|   | B-1 .....   | 4-7               |                          |  |                 |
|   | HDD   |                   |                          |  |                 |
|   | H-1 .....   | 4-9               |                          |  |                 |
|   | LCD   |                   |                          |  |                 |
|   | L-1. 10.6-inch TFT WXGA (Brightness) — Made by SH — ..... | 4-11              |                          |  |                 |
|   | Accessories   |                   |                          |  |                 |
|   | A-1 .....   | 4-13<br>(to 4-13) |                          |  |                 |

History of the changes is shown as the "Revision History" at the end of this data.

変更履歴は、“Revision History”として、本データ末に記載してあります。

**Confidential**

VGN-T52B/T72B/T72PZ/T92PS/T92PSY/T92S (J)  
VGN-T330FP/T340P/T350/T350P/T360P/T370P (AM)  
VGN-T36SP/T37C/T37GP/T37TP (AO)

# CHAPTER 1. SPECIFICATIONS

## 1-1. Specifications

| J               |                       |                       |                       |                       |   |   |   | AM                           |
|-----------------|-----------------------|-----------------------|-----------------------|-----------------------|---|---|---|------------------------------|
| Model           | VGN-T72B/L            | VGN-T72B/T            | VGN-T52B/L            | VGN-T72PZ             | VGN-T92PS*  | VGN-T92S*   | VGN-T92PSY*   | VGN-T370P/L                  |
| CPU             | ULV-PM/Do/753/1.20GHz | ULV-PM/Do/753/1.20GHz | ULV-CelM/Do/373/1GHz  | ULV-PM/Do/753/1.20GHz | ULV-PM/Do/753/1.20GHz or ULV-CelM/Do/373/1GHz                   | ULV-PM/Do/753/1.20GHz or ULV-CelM/Do/373/1GHz                   | ULV-PM/Do/753/1.20GHz or ULV-CelM/Do/373/1GHz                   | ULV-PM/Do/753/1.20GHz        |
| Chipset         | Intel 855GME          | Intel 855GME          | Intel 855GME          | Intel 855GME          | Intel 855GME  | Intel 855GME  | Intel 855GME  | Intel 855GME                 |
| LCD             | 10.6/WXGA/BR          | 10.6/WXGA/BR          | 10.6/WXGA/BR          | 10.6/WXGA/BR          | 10.6/WXGA/BR  | 10.6/WXGA/BR  | 10.6/WXGA/BR  | 10.6/WXGA/BR                 |
| HDD             | 60GB                  | 60GB                  | 60GB                  | 40GB                  | 60GB or 40GB  | 60GB or 40GB  | 60GB or 40GB  | 60GB                         |
| Memory          | 512MB on-board        | 512MB on-board        | 256MB on-board        | 512MB on-board        | 1GB(512MB on-board+512MBx1) or 512MB on-board or 256MB on-board | 1GB(512MB on-board+512MBx1) or 512MB on-board or 256MB on-board | 1GB(512MB on-board+512MBx1) or 512MB on-board or 256MB on-board | 1GB (512MB on-board+512MBx1) |
| QUANTITY[MAX]   | 1GB                   | 1GB                   | 768MB                 | 1GB                   | 1GB(512MB on-board model) or 768MB(256 on-board model)          | 1GB(512MB on-board model) or 768MB(256 on-board model)          | 1GB(512MB on-board model) or 768MB(256 on-board model)          | 1GB                          |
| Optical         | SuperMulti/9.5/x4/+DL | SuperMulti/9.5/x4/+DL | SuperMulti/9.5/x4/+DL | Combo/9.5/x24         | Combo/9.5/x24 or SuperMulti/9.5/x4/+DL                          | Combo/9.5/x24 or SuperMulti/9.5/x4/+DL                          | Combo/9.5/x24 or SuperMulti/9.5/x4/+DL                          | DVD+-RW/9.5/x4/+DL           |
| Wireless LAN    | 802.11b/g             | 802.11b/g             | 802.11b/g             | 802.11b/g             | 802.11b/g   | 802.11b/g   | 802.11b/g   | 802.11b/g                    |
| Wireless WAN    | x                     | x                     | x                     | x                     | x   | x   | x   | ○                            |
| Bluetooth       | x                     | x                     | x                     | x                     | x   | x   | x   | ○                            |
| Felica          | ○                     | ○                     | ○                     | ○                     | ○ or x  | ○ or x  | ○ or x  | x                            |
| AC adaptor      | VGP-AC16V7            | VGP-AC16V7            | VGP-AC16V7            | VGP-AC16V7            | VGP-AC16V7  | VGP-AC16V7  | VGP-AC16V7  | VGP-AC16V8                   |
| Battery         | VGP-BPS3A             | VGP-BPS3A             | VGP-BPS3A             | VGP-BPS3A             | VGP-BPS3A   | VGP-BPS3A   | VGP-BPS3A   | VGP-BPS3A                    |
| Color Variation | Blue                  | Brown                 | Blue                  | Blue                  | Silver or Brown or Blue or Carbon                               | Silver or Brown or Blue or Carbon                               | Silver or Brown or Blue or Carbon                               | Blue                         |
| Keyboard        | Japanese Key Board    | Japanese Key Board    | Japanese Key Board    | Japanese Key Board    | English Key Board or Japanese Key Board                         | English Key Board or Japanese Key Board                         | English Key Board or Japanese Key Board                         | English Key Board            |
| OS              | XP Home               | XP Home               | XP Home               | XP Pro                | XP Pro  | XP Home   | XP Pro  | XP Pro                       |
| Office          | 2003 Personal         | 2003 Personal         | 2003 Personal         | None                  | 2003 Personal or 2003 Professional or None                      | 2003 Personal or 2003 Professional or None                      | 2003 Personal or 2003 Professional or None                      | None                         |

△ [MA]

△ [MA]

| AM              |                       |                       |                       |                       |                             |                       |                       |                       |
|-----------------|-----------------------|-----------------------|-----------------------|-----------------------|-----------------------------|-----------------------|-----------------------|-----------------------|
| Model           | VGN-T350P/L           | VGN-T350P/S           | VGN-T350P/T           | VGN-T350/L            | VGN-T360P/L                 | VGN-T340P/L           | VGN-T330FP/L          | VGN-T330FP/T          |
| CPU             | ULV-PM/Do/753/1.20GHz | ULV-PM/Do/753/1.20GHz | ULV-PM/Do/753/1.20GHz | ULV-PM/Do/753/1.20GHz | ULV-PM/Do/753/1.20GHz       | ULV-PM/Do/753/1.20GHz | ULV-PM/Do/753/1.20GHz | ULV-PM/Do/753/1.20GHz |
| Chipset         | Intel 855GME          | Intel 855GME          | Intel 855GME          | Intel 855GME          | Intel 855GME                | Intel 855GME          | Intel 855GME          | Intel 855GME          |
| LCD             | 10.6/WXGA/BR          | 10.6/WXGA/BR          | 10.6/WXGA/BR          | 10.6/WXGA/BR          | 10.6/WXGA/BR                | 10.6/WXGA/BR          | 10.6/WXGA/BR          | 10.6/WXGA/BR          |
| HDD             | 60GB                  | 60GB                  | 60GB                  | 60GB                  | 60GB                        | 60GB                  | 60GB                  | 60GB                  |
| Memory          | 512MB on-board        | 512MB on-board        | 512MB on-board        | 512MB on-board        | 1GB(512MB on-board+512MBx1) | 512MB on-board        | 512MB on-board        | 512MB on-board        |
| QUANTITY[MAX]   | 1GB                   | 1GB                   | 1GB                   | 1GB                   | 1GB                         | 1GB                   | 1GB                   | 1GB                   |
| Optical         | DVD+-RW/9.5/x4/+DL    | DVD+-RW/9.5/x4/+DL    | DVD+-RW/9.5/x4/+DL    | DVD+-RW/9.5/x4/+DL    | Combo/9.5/x24               | Combo/9.5/x24         | DVD+-RW/9.5/x4/+DL    | DVD+-RW/9.5/x4/+DL    |
| Wireless LAN    | 802.11b/g             | 802.11b/g             | 802.11b/g             | 802.11b/g             | 802.11b/g                   | 802.11b/g             | 802.11b/g             | 802.11b/g             |
| Wireless WAN    | ○                     | ○                     | ○                     | ○                     | ○                           | ○                     | x                     | x                     |
| Bluetooth       | ○                     | ○                     | ○                     | ○                     | ○                           | ○                     | x                     | x                     |
| Felica          | x                     | x                     | x                     | x                     | x                           | x                     | x                     | x                     |
| AC adaptor      | VGP-AC16V8            | VGP-AC16V8            | VGP-AC16V8            | VGP-AC16V8            | VGP-AC16V8                  | VGP-AC16V8            | VGP-AC16V8            | VGP-AC16V8            |
| Battery         | VGP-BPS3A             | VGP-BPS3A             | VGP-BPS3A             | VGP-BPS3A             | VGP-BPS3A                   | VGP-BPS3A             | VGP-BPS3A             | VGP-BPS3A             |
| Color Variation | Blue                  | Silver                | Brown                 | Blue                  | Blue                        | Blue                  | Blue                  | Brown                 |
| Keyboard        | English Key Board     | English Key Board     | English Key Board     | English Key Board     | English Key Board           | English Key Board     | -                     | -                     |
| OS              | XP Pro                | XP Pro                | XP Pro                | XP Home               | XP Pro                      | XP Pro                | XP Pro                | XP Pro                |
| Office          | None                  | None                  | None                  | None                  | None                        | None                  | None                  | None                  |

△ [MA]

△ [MA]

△ [MA]

△ [MA]

△ [MA]

△ [MA]

△ [MA]

△ [MA]

- The trademarks of registered trademarks of above table, refer to page 2.
- The model that is accompanied by asterisk (\*) is the CTO model.
- As for the T92PSY, the Specifications are different from each Product Code. Please refer to the page 4-2 for how to identify the Product Code.
- 本表中の商標・登録商標については、2ページをご参照ください。
- 機種名に(\*)がつくものはCTOモデルです。
- T92PSYはProduct CodeによってSpecificationsが違います。Product Codeの確認方法は4-2ページを参照してください。

**Confidential**

VGN-T52B/T72B/T72PZ/T92PS/T92S/T92S (J)  
VGN-T330FP/T340P/T350/T350P/T360P/T370P (AM)  
VGN-T36SP/T37C/T37GP/T37TP (AO)

| AO              |                          |                          |                          |                          |                       |                       |
|-----------------|--------------------------|--------------------------|--------------------------|--------------------------|-----------------------|-----------------------|
| Model           | VGN-T37GP/L              | VGN-T37GP/S              | VGN-T37TP/L              | VGN-T37TP/S              | VGN-T36SP/S           | VGN-T37C/L            |
| CPU             | ULV-PM/Do/753/1.20GHz    | ULV-PM/Do/753/1.20GHz    | ULV-PM/Do/753/1.20GHz    | ULV-PM/Do/753/1.20GHz    | ULV-PM/Do/733/1.10GHz | ULV-PM/Do/753/1.20GHz |
| Chipset         | Intel 855GME             | Intel 855GME             | Intel 855GME             | Intel 855GME             | Intel 855GME          | Intel 855GME          |
| LCD             | 10.6/WXGA/BR             | 10.6/WXGA/BR             | 10.6/WXGA/BR             | 10.6/WXGA/BR             | 10.6/WXGA/BR          | 10.6/WXGA/BR          |
| HDD             | 60GB<br>1GB              | 60GB<br>1GB              | 60GB<br>1GB              | 60GB<br>1GB              | 60GB                  | 60GB                  |
| Memory          | (512MB on-board+512MBx1) | (512MB on-board+512MBx1) | (512MB on-board+512MBx1) | (512MB on-board+512MBx1) | 512MB on-board        | 512MB on-board        |
| QUANTITY[MAX]   | 1GB                      | 1GB                      | 1GB                      | 1GB                      | 1GB                   | 1GB                   |
| Optical         | DVD+-RW/9.5/x4/+DL       | DVD+-RW/9.5/x4/+DL       | DVD+-RW/9.5/x4/+DL       | DVD+-RW/9.5/x4/+DL       | Combo/9.5/x24         | DVD+-RW/9.5/x4/+DL    |
| Wireless LAN    | 802.11b/g                | 802.11b/g                | 802.11b/g                | 802.11b/g                | 802.11b/g             | 802.11b/g             |
| Wireless WAN    | x                        | x                        | x                        | x                        | x                     | x                     |
| Bluetooth       | ○                        | ○                        | ○                        | ○                        | x                     | ○                     |
| Felica          | x                        | x                        | x                        | x                        | x                     | x                     |
| AC adaptor      | VGP-AC16V8               | VGP-AC16V8               | VGP-AC16V8               | VGP-AC16V8               | VGP-AC16V8            | VGP-AC16V8            |
| Battery         | VGP-BPS3A                | VGP-BPS3A                | VGP-BPS3A                | VGP-BPS3A                | VGP-BPS3A             | VGP-BPS3A             |
| Color Variation | Blue                     | Silver                   | Blue                     | Silver                   | Silver                | Blue                  |
| Keyboard        | English Key Board        | English Key Board        | English Key Board        | English Key Board        | English Key Board     | English Key Board     |
| OS              | XP Pro                   | XP Pro                   | XP Pro                   | XP Pro                   | XP Pro                | XP Home               |
| Office          | None                     | None                     | None                     | None                     | None                  | None                  |
|                 | △ [MA]                   | △ [MA]                   | △ [MA]                   | △ [MA]                   | △ [MA]                | △ [MA]                |

- The trademarks of registered trademarks of above table, refer to page 2.
- The model that is accompanied by asterisk (\*) is the CTO model.
- 本表中の商標・登録商標については、2ページをご参照ください。
- 機種名に (\*) がつくものはCTOモデルです。

△ [MA]

**Confidential**

VGN-T52B/T72B/T72PZ/T92PS/T92PSY/T92S (J)  
VGN-T330FP/T340P/T350/T350P/T360P/T370P (AM)  
VGN-T36SP/T37C/T37GP/T37TP (AO)

# CHAPTER 2. BLOCK DIAGRAM

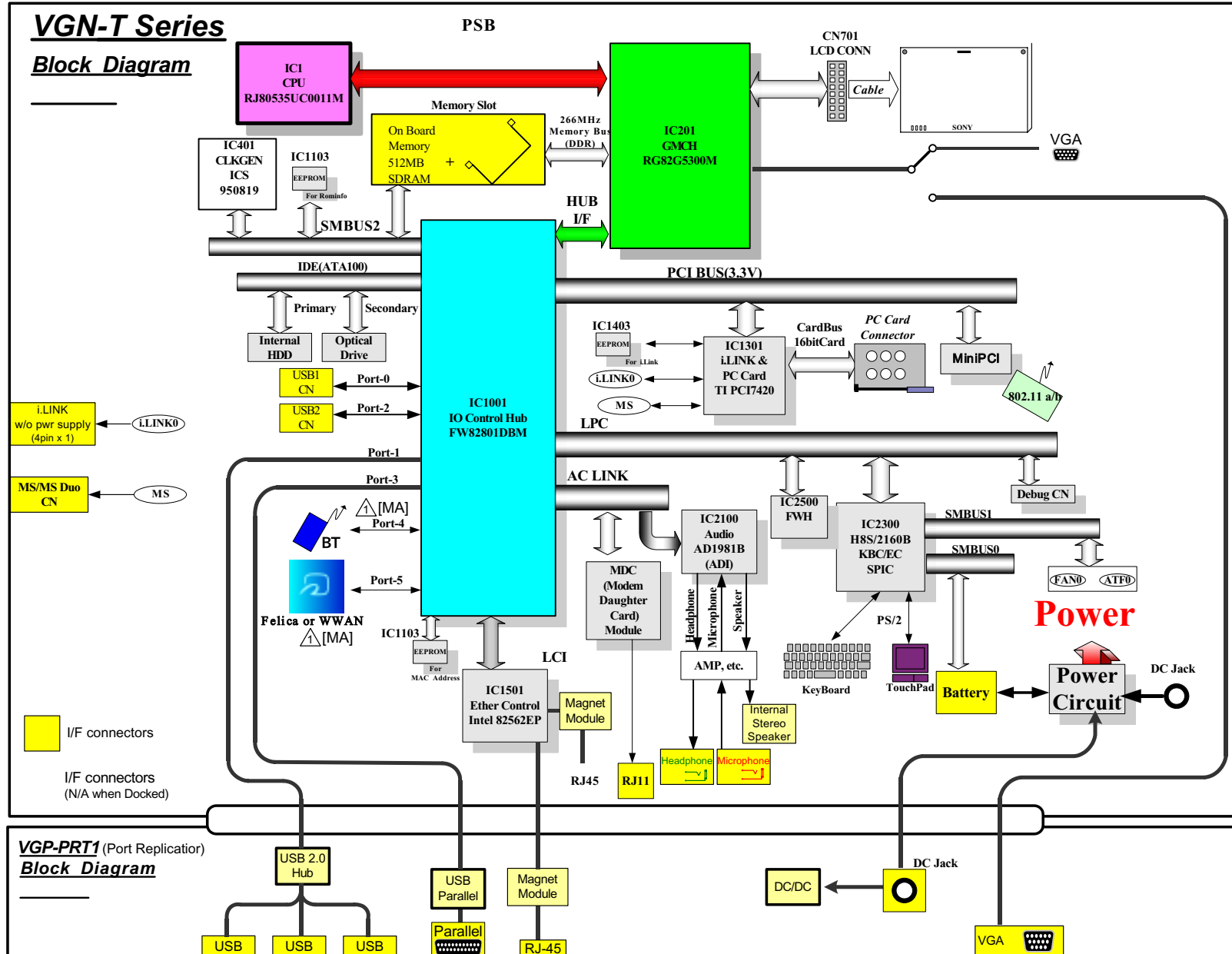

Confidential

VGN-T52B/T72B/T72PZ/T92PS/T92S (J)  
VGN-T330FP/T340P/T350/T350P/T360P/T370P (AM)  
VGN-T36SP/T37C/T37GP/T37TP (AO)

# CHAPTER 3. FRAME HARNESS DIAGRAM

— HDD HI —

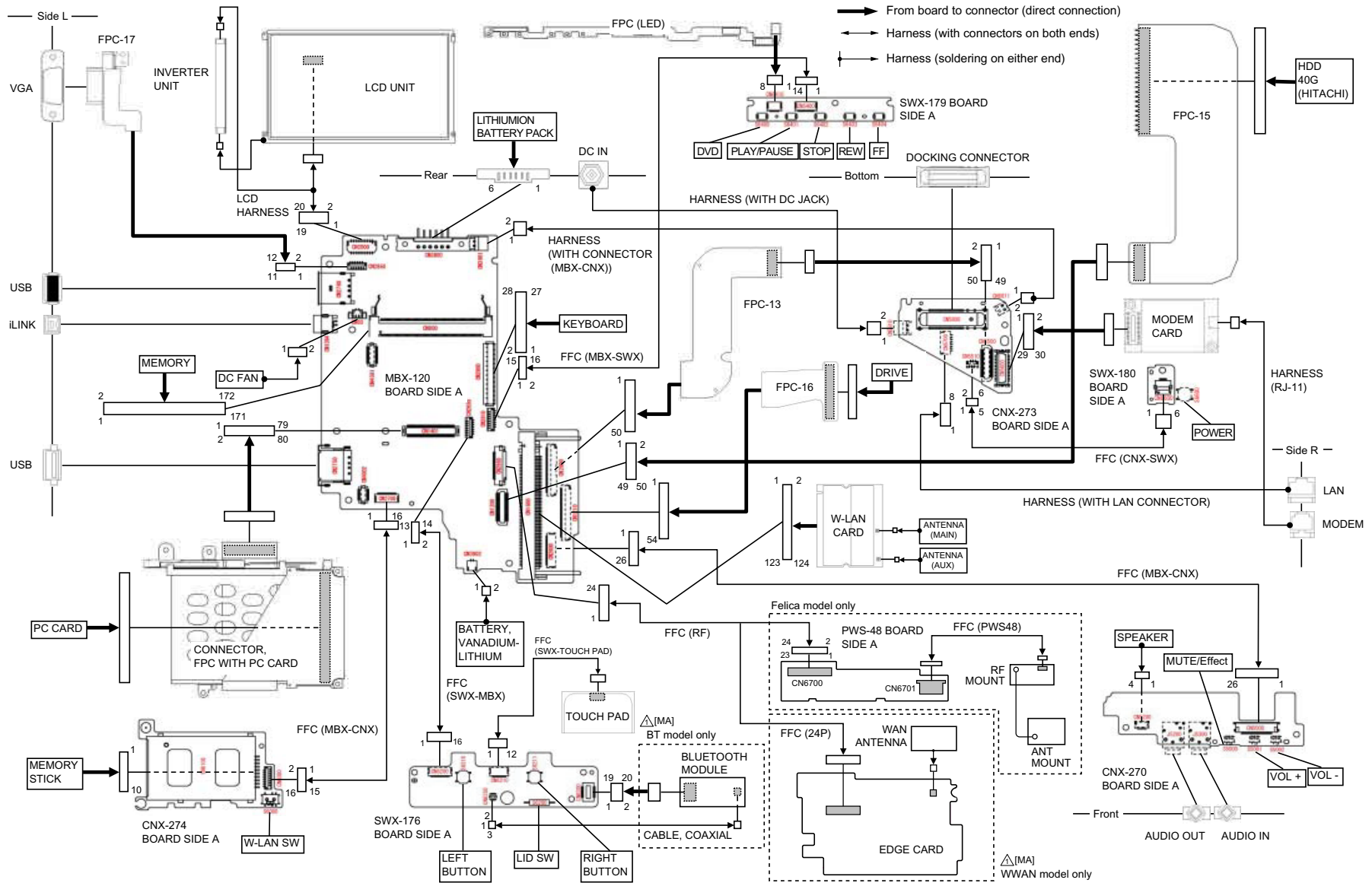

**Confidential**

VGN-T52B/T72B/T72PZ/T92PS/T92PSY/T92S (J)  
VGN-T330FP/T340P/T350/T350P/T360P/T370P (AM)  
VGN-T36SP/T37C/T37GP/T37TP (AO)

- HDD TO -

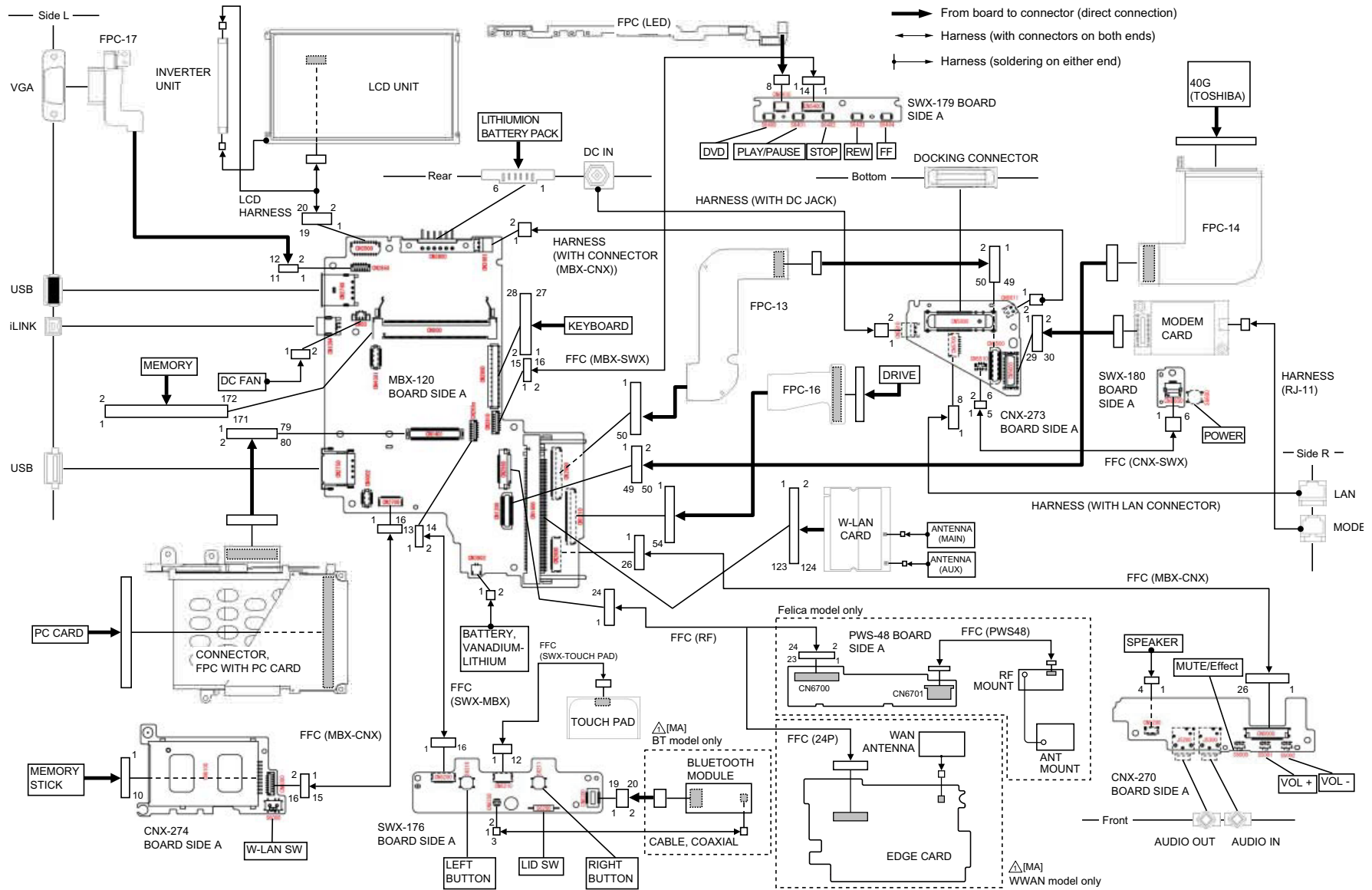

# CHAPTER 4.

## EXPLODED VIEWS AND PARTS LIST

• The parts list is compiled by blocks of a palmrest and bottom etc.  
The sections of the parts list are different depending on the model.  
Please refer to list of contents shown in the below.

• 分解図と部品表は、パームレスト、ボトムなどのブロックごとに分かれていません。機種によって部品表のセクションが異なりますので、詳細は右下の一覧表を参照してください。

| Section                                     | Page |
|---|------|
| <b>How to identify the VGN-T92PSY</b> ..... | 4-2  |
| <b>Palmrest</b>                             |      |
| P-1 .....                                   | 4-3  |
| <b>Main Board</b>                           |      |
| M-1 .....                                   | 4-5  |
| <b>Bottom</b>                               |      |
| B-1 .....                                   | 4-7  |
| <b>HDD</b>                                  |      |
| H-1 .....                                   | 4-9  |
| <b>LCD</b>                                  |      |
| L-1. 10.6-inch TFT WXGA (Brightness)        |      |
| — Made by SH — .....                        | 4-11 |
| <b>Accessory</b>                            |      |
| A-1 .....                                   | 4-13 |

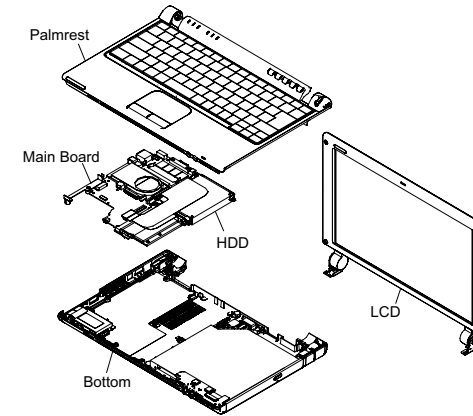

**NOTE:**

- Items marked "" are not stocked since they are seldom required for routine service. Some delay should be anticipated when ordering these items.
- The mechanical parts with no reference number in the exploded views are not supplied.
- When two or more parts are shown, use the part described first as the main part.
- The parts marked "\$" are the High Value Modules (HVM).
- The parts marked "#" are the parts on which barcode label is attached. For the barcode label, refer to CHAPTER 5.
- The parts marked "&" are the "Customer Replacable Parts (CRP)" that can be replaced by Field Customer Support.
- Especially the parts with the "<&" mark require the special attention to use them. Here fore, check first whether the desired part is one of the targetted parts of the Customer Replacable Parts (CRP), or the non-targetted parts by referring to the exploded view.

**【使用上の注意】**

- \*印の部品は常備在庫しておりません。
- 図面番号のない部品は供給しません。
- 併記部品の場合、上部記載部品をメイン部品として使用してください。
- 部品名称の前に\$印のついた部品は、High Value Module (HVM) です。
- 商品名称の前に#印のついた部品は、バーコードラベル貼付部品です。
- パーコードラベルについてはCHAPTER 5を参照してください。
- 部品名称の前に&印のついた部品は、お客様窓口などでも交換可能なCustomer Replacable Part (CRP) です。
- 特に<&印のついた部品は、使い分けが必要な部品ですので、分解図でCustomer Replacable Parts対象部品か、対象外部品かを必ず御確認ください。

The components identified by mark △ or dotted line with mark △ are critical for safety. Replace only with part number specified.

Les composants identifiés par une marque △ sont critiques pour la sécurité. Ne les remplacer que par une pièce portant le numéro spécifié.

△印の部品、または△印付きの点線で囲まれた部品は、安全性を維持するために重要な部品です。従って交換時は、必ず指定の部品を使用して下さい。

△ [MA]

△ [MA]

△ [MA]

△ [MA]

△ [MA]

△ [MA]

△ [MA]

△ [MA]

△ [MA]

△ [MA]

△ [MA]

△ [MA]

△ [MA]

△ [MA]

△ [MA]

|        |    | Palmrest | Main Board | Bottom | HDD | LCD | Accessory |     |
|--------|----|----------|------------|--------|-----|-----|-----------|-----|
| △ [MA] | J  | T72B/L   | P-1        | M-1    | B-1 | H-1 | L-1       | A-1 |
|        |    | T72B/T   | P-1        | M-1    | B-1 | H-1 | L-1       | A-1 |
|        |    | T52B/L   | P-1        | M-1    | B-1 | H-1 | L-1       | A-1 |
|        |    | T72PZ    | P-1        | M-1    | B-1 | H-1 | L-1       | A-1 |
|        |    | T92PS*   | P-1        | M-1    | B-1 | H-1 | L-1       | A-1 |
|        |    | T92S*    | P-1        | M-1    | B-1 | H-1 | L-1       | A-1 |
|        |    | T92PSY*  | P-1        | M-1    | B-1 | H-1 | L-1       | A-1 |
| △ [MA] | AM | T370P/L  | P-1        | M-1    | B-1 | H-1 | L-1       | A-1 |
|        |    | T350P/L  | P-1        | M-1    | B-1 | H-1 | L-1       | A-1 |
|        |    | T350P/S  | P-1        | M-1    | B-1 | H-1 | L-1       | A-1 |
|        |    | T350P/T  | P-1        | M-1    | B-1 | H-1 | L-1       | A-1 |
|        |    | T350/L   | P-1        | M-1    | B-1 | H-1 | L-1       | A-1 |
|        |    | T360P/L  | P-1        | M-1    | B-1 | H-1 | L-1       | A-1 |
| △ [MA] | AO | T340P/L  | P-1        | M-1    | B-1 | H-1 | L-1       | A-1 |
|        |    | T330FP/L | P-1        | M-1    | B-1 | H-1 | L-1       | A-1 |
|        |    | T330FP/T | P-1        | M-1    | B-1 | H-1 | L-1       | A-1 |
|        |    | T37GP/L  | P-1        | M-1    | B-1 | H-1 | L-1       | A-1 |
|        |    | T37GP/S  | P-1        | M-1    | B-1 | H-1 | L-1       | A-1 |
|        |    | T37TP/L  | P-1        | M-1    | B-1 | H-1 | L-1       | A-1 |
|        |    | T37TP/S  | P-1        | M-1    | B-1 | H-1 | L-1       | A-1 |
|        |    | T36SP/S  | P-1        | M-1    | B-1 | H-1 | L-1       | A-1 |
|        |    | T37C/L   | P-1        | M-1    | B-1 | H-1 | L-1       | A-1 |

\* : CTO model

**Confidential**

VGN-T52B/T72B/T72PZ/T92PS/T92PSY/T92S (J)  
VGN-T330FP/T340P/T350/T350P/T360P/T370P (AM)  
VGN-T36SP/T37C/T37GP/T37TP (AO)

## How to identify the VGN-T92PSY VGN-T92PSYの判別方法

The T92PSY is using different parts by the Product Code.  
Check the Product Code. with the Set, then refer to the corresponding section of the parts list and select the parts to be used.

T92PSYはProduct Codeによって使用する部品が違います。  
セットでProduct Codeを確認してから、部品表の該当箇所を参照し、使用する部品を選択してください。

### 【How to identify the VGN-T92PSY】 【Product Codeの確認方法】

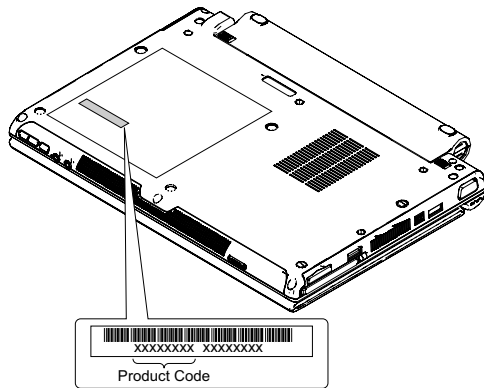

### 【Example of Parts List】 【部品表記載例】

Check the Product Code in parentheses which is written beside a model name, and select the parts to be used.  
機種名の横に記載されている、括弧内のProduct Codeを確認してから、使用する部品を選択してください。

| Ref.No. | Part No.     | Description                     | J     |       |       |       |        |                       | AM                    |         |
|---------|--------------|---------------------------------|-------|-------|-------|-------|--------|-----------------------|-----------------------|---------|
|         |              |                                 | T72BL | T72BT | T92BL | T72PZ | T92PS* | T92PS*<br>(281 97404) | T92PS*<br>(281 97405) | T370P/L |
| 2       | 1-805-554-21 | BLUETOOTH MODULE                |       |       |       |       |        |                       | ●                     | ●       |
| 3       | X-2022-970-1 | BRACKET (PAC) ASSY              |       |       |       |       |        |                       | ●                     | ●       |
| 6       | 1-827-266-41 | CABLE, COAXIAL (WITH U.F.L CON) |       |       |       | ●     | ●      |                       | ●                     | ●       |
| 20      | 1-478-986-11 | # KEYBOARD UNIT (JP)            | ●     | ●     |       |       |        |                       |                       |         |
|         | 1-478-986-21 | # KEYBOARD UNIT (US)            |       |       | ●     |       | ●      |                       |                       |         |
|         | 1-478-986-41 | # KEYBOARD UNIT (TH)            |       |       |       |       |        |                       |                       |         |

Confidential

VGN-T52B/T72B/T72PZ/T92PS/T92PSY/T92S (J)  
VGN-T330FP/T340P/T350/T350P/T360P/T370P (AM)  
VGN-T36SP/T37C/T37GP/T37TP (AO)

P-1. Palmrest

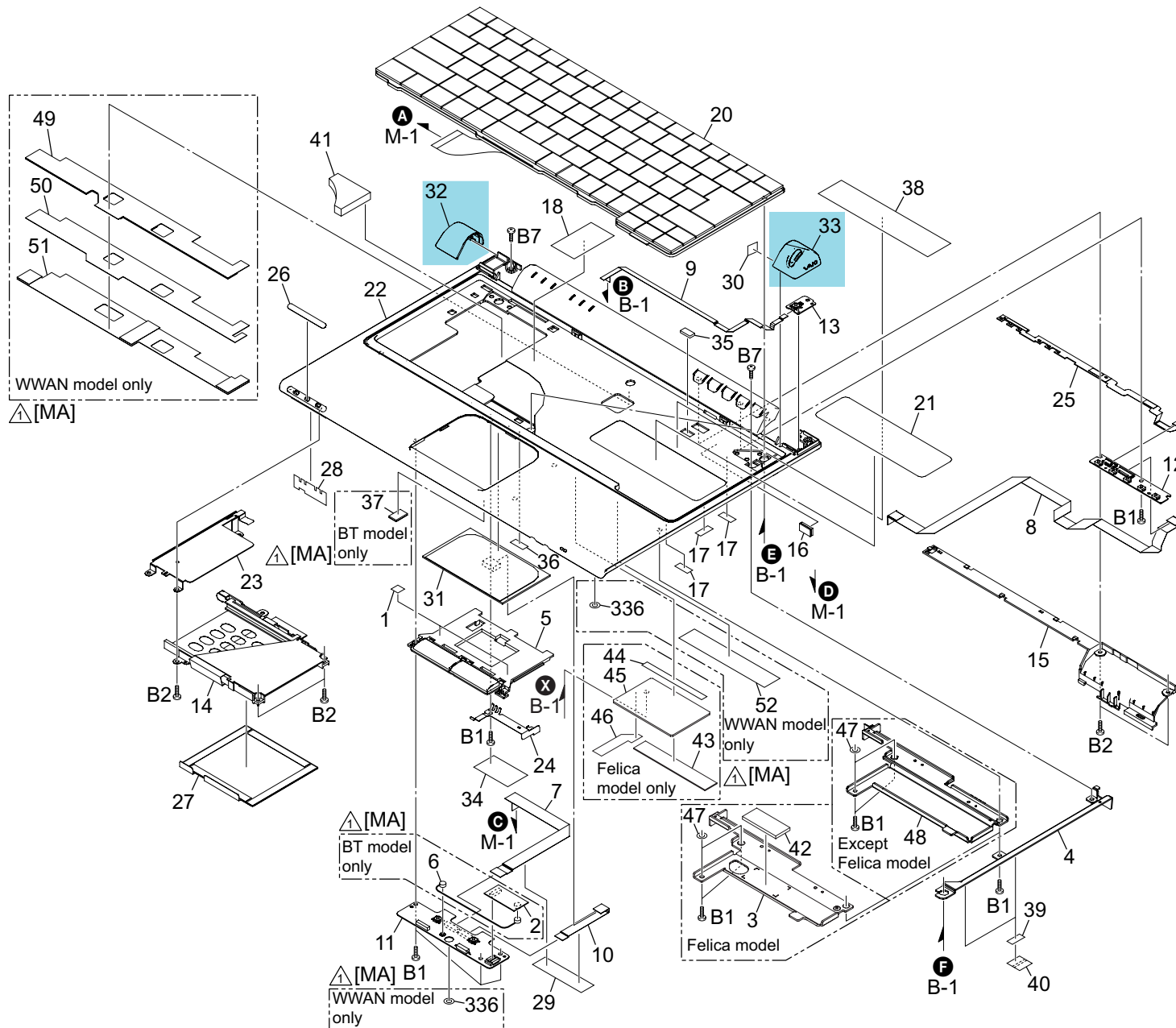

Confidential

VGN-T52B/T72B/T72PZ/T92PS/T92PSY/T92S (J)  
VGN-T330FP/T340P/T350/T350P/T360P/T370P (AM)  
VGN-T36SP/T37C/T37GP/T37TP (AO)

# P-1. Palmrest

| Ref.No. | Part No.     | Description                    |
|---------|--------------|--------------------------------|
| 1       | 2-349-366-01 | ADHESIVE TAPE(TP)              |
| 4       | 2-159-841-01 | BRACKET (PAR)                  |
| 5       | X-2024-925-2 | BUTTON TP ASSY                 |
| 7       | 1-829-795-11 | CABLE,FLEXIBLE FLAT (SWX176)   |
| 8       | 1-829-797-13 | CABLE,FLEXIBLE FLAT (SWX179)   |
| 9       | 1-829-798-13 | CABLE,FLEXIBLE FLAT (SWX180)   |
| 10      | 1-829-796-11 | CABLE,FLEXIBLE FLAT (TP)       |
| 11      | A-1090-038-A | SWX-176 (S)                    |
| 12      | A-1090-039-A | SWX-179 (S)                    |
| 13      | A-1090-040-A | SWX-180 (S)                    |
| 14      | 1-818-866-11 | CONNECTOR, FPC WITH PC CARD    |
| 15      | 2-159-838-01 | COVER (PALM)                   |
| 16      | 2-187-193-01 | CUSHION (OP)                   |
| 17      | 2-349-529-01 | CUSHION (PA)                   |
| 18      | 2-546-040-01 | SHEET (KEYBOARD)               |
| 21      | 2-187-191-01 | LASER CAUTION LABEL            |
| 23      | 2-159-840-01 | PLATE (PCC), SHIELD            |
| 24      | 2-159-835-01 | PLATE (TP), GROUND             |
| 25      | 1-864-361-11 | PWB,FLEXIBLE (LED)             |
| 27      | 2-187-194-02 | SHEET (PCC)                    |
| 28      | 2-349-375-02 | SHEET (WLAN PALM)              |
| 29      | 4-676-302-01 | TAPE (COMMON)                  |
| 30      | 2-546-036-01 | GASKET (COVER HR)              |
| 31      | 1-796-958-21 | TOUCH PAD                      |
| 32      | 2-159-836-02 | & COVER (HL)                   |
| 33      | X-2022-969-2 | & COVER (HR) ASSY              |
| 34      | 4-658-789-02 | TAPE (HARNES)                  |
| 35      | 2-546-041-01 | CUSHION (POP UP)               |
| 36      | 2-546-039-02 | SHEET (BKT PALM)               |
| 38      | 2-548-815-01 | SHEET (KEYBOARD RIGHT)         |
| 39      | 2-548-771-01 | SHEET BKT PALM R S             |
| 40      | 2-548-772-01 | SHEET BKT PALM R B             |
| 41      | 2-349-364-01 | CUSHION(KB)                    |
| 47      | 2-583-785-01 | SPACER O                       |
| B1      | 4-676-936-01 | +SCREW,O2 +SPECIAL HEAD SELF S |
| B2      | 4-642-229-01 | TAPPING (B 2X)                 |
| B7      | 4-672-834-31 | SCREW, +B EG GRIP              |

| Ref.No. | Part No. | Description  | J                               |       |       |       |        |       |         |                       |                       |         | AM      |         |         |       |         | AO      |         |          |         |         |         |         |         |        |  |
|---------|----------|--------------|---------------------------------|-------|-------|-------|--------|-------|---------|-----------------------|-----------------------|---------|---------|---------|---------|-------|---------|---------|---------|----------|---------|---------|---------|---------|---------|--------|--|
|         |          |              | T72BL                           | T72BT | T52BL | T72PZ | T92PS* | T92S* | T92PSY* | T92PSY*<br>(28197404) | T92PSY*<br>(28197405) | T370PAL | T350PIL | T350PIS | T350PIT | T350L | T340PIL | T340PIL | T360PIL | T330FPIT | T370PIL | T37GPIS | T37TPIL | T37TPIS | T36SPIS | T37CIL |  |
| △ [MA]  | 2        | 1-805-554-21 | BLUE TOOTH MODULE               |       |       |       |        |       |         |                       |                       |         |         |         |         |       |         |         |         |          |         |         |         |         |         |        |  |
|         | 3        | X-2022-970-1 | BRACKET (PAC) ASSY              |       |       |       |        |       |         |                       |                       |         |         |         |         |       |         |         |         |          |         |         |         |         |         |        |  |
| △ [MA]  | 6        | 1-827-266-41 | CABLE, COAXIAL (WITH U.F.L CON) |       |       |       |        |       |         |                       |                       |         |         |         |         |       |         |         |         |          |         |         |         |         |         |        |  |
|         | 20       | 1-478-986-11 | # KEYBOARD UNIT (JP)            |       |       |       |        |       |         |                       |                       |         |         |         |         |       |         |         |         |          |         |         |         |         |         |        |  |
|         |          | 1-478-986-21 | # KEYBOARD UNIT (US)            |       |       |       |        |       |         |                       |                       |         |         |         |         |       |         |         |         |          |         |         |         |         |         |        |  |
| △ [MA]  |          | 1-478-986-41 | # KEYBOARD UNIT (TH)            |       |       |       |        |       |         |                       |                       |         |         |         |         |       |         |         |         |          |         |         |         |         |         |        |  |
| △ [MA]  |          | 1-478-986-51 | # KEYBOARD UNIT (TW)            |       |       |       |        |       |         |                       |                       |         |         |         |         |       |         |         |         |          |         |         |         |         |         |        |  |
| △ [MA]  |          | 1-478-988-71 | # KEYBOARD UNIT (LA)            |       |       |       |        |       |         |                       |                       |         |         |         |         |       |         |         |         |          |         |         |         |         |         |        |  |
| △ [MA]  |          | 1-478-986-81 | # KEYBOARD UNIT (US)            |       |       |       |        |       |         |                       |                       |         |         |         |         |       |         |         |         |          |         |         |         |         |         |        |  |
|         | 22       | X-2022-969-3 | PALMREST ASSY                   |       |       |       |        |       |         |                       |                       |         |         |         |         |       |         |         |         |          |         |         |         |         |         |        |  |
|         |          | X-2048-665-2 | HOUSING PALMREST ASSY (F)       |       |       |       |        |       |         |                       |                       |         |         |         |         |       |         |         |         |          |         |         |         |         |         |        |  |
| △ [MA]  | 26       | 2-159-839-02 | & SHEET (LED)                   |       |       |       |        |       |         |                       |                       |         |         |         |         |       |         |         |         |          |         |         |         |         |         |        |  |
|         |          | 2-159-836-12 | & SHEET (LED)                   |       |       |       |        |       |         |                       |                       |         |         |         |         |       |         |         |         |          |         |         |         |         |         |        |  |
| △ [MA]  |          | 2-159-838-21 | & SHEET (LED)                   |       |       |       |        |       |         |                       |                       |         |         |         |         |       |         |         |         |          |         |         |         |         |         |        |  |
| △ [MA]  | 37       | 2-187-192-01 | CUSHION (BTM)                   |       |       |       |        |       |         |                       |                       |         |         |         |         |       |         |         |         |          |         |         |         |         |         |        |  |
|         | 42       | 2-580-564-01 | CUSHION ANTENNA (F)             |       |       |       |        |       |         |                       |                       |         |         |         |         |       |         |         |         |          |         |         |         |         |         |        |  |
|         | 43       | 2-586-421-01 | BUSTERAID ANTENNA (F)           |       |       |       |        |       |         |                       |                       |         |         |         |         |       |         |         |         |          |         |         |         |         |         |        |  |
|         | 44       | 2-580-566-01 | ADHESIVE TAPE ANTENNA (F)       |       |       |       |        |       |         |                       |                       |         |         |         |         |       |         |         |         |          |         |         |         |         |         |        |  |
|         | 45       | A-1104-126-A | \$ ANT MOUNT PWB (S)            |       |       |       |        |       |         |                       |                       |         |         |         |         |       |         |         |         |          |         |         |         |         |         |        |  |
|         | 46       | 2-590-815-02 | GUIDE (F), SHEET                |       |       |       |        |       |         |                       |                       |         |         |         |         |       |         |         |         |          |         |         |         |         |         |        |  |
|         | 48       | X-2048-680-2 | BRACKET PALMREST C ASSY (F)     |       |       |       |        |       |         |                       |                       |         |         |         |         |       |         |         |         |          |         |         |         |         |         |        |  |
| △ [MA]  | 49       | 2-595-173-01 | TAPE (PARM) (A), SHIELD         |       |       |       |        |       |         |                       |                       |         |         |         |         |       |         |         |         |          |         |         |         |         |         |        |  |
| △ [MA]  | 50       | 2-595-174-01 | TAPE (PARM) (B), SHIELD         |       |       |       |        |       |         |                       |                       |         |         |         |         |       |         |         |         |          |         |         |         |         |         |        |  |
| △ [MA]  | 51       | 2-629-984-01 | PARM, INSULATING SHEET          |       |       |       |        |       |         |                       |                       |         |         |         |         |       |         |         |         |          |         |         |         |         |         |        |  |
| △ [MA]  | 52       | 2-637-094-01 | BUSTERAID PALM(G)               |       |       |       |        |       |         |                       |                       |         |         |         |         |       |         |         |         |          |         |         |         |         |         |        |  |
| △ [MA]  | 336      | 2-187-373-01 | SPACER(FAN)                     |       |       |       |        |       |         |                       |                       |         |         |         |         |       |         |         |         |          |         |         |         |         |         |        |  |

- This parts list contains two different types of parts.  
The first type is the parts that are common to all models.  
The other type is the parts that are different depending on each model.
- As for the T92PSY, check the Product Code in a parenthesis which is written beside the model name, and select the parts to be used.  
Please refer to the page 4-2 for how to identify the Product Code.

- この部品表は、機種共通の部品と、機種によって使い分けが必要な部品に分かれています。
- T92PSYは機種名の横に記載されている、括弧内のProduct Codeを確認してから、使用する部品を選択してください。  
Product Codeの確認方法は4-2ページを参照してください。

M-1.Main Board

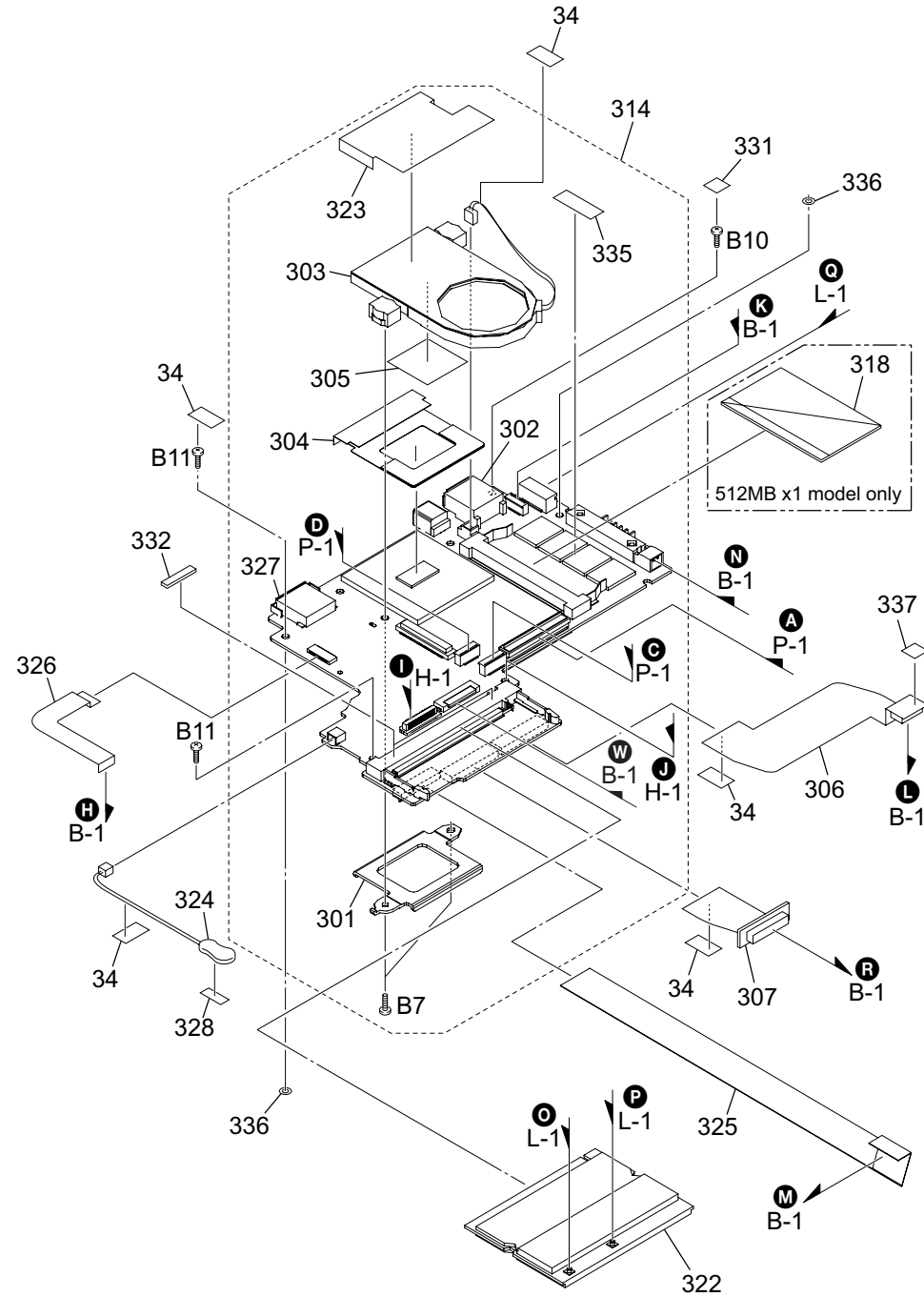

# M-1.Main Board

| Ref.No. | Part No.     | Description               |
|---------|--------------|---------------------------|
| 34      | 4-658-789-02 | TAPE (HARNESS)            |
| 301     | 2-159-880-01 | BRACKET (CPU)             |
| 302     | 1-794-548-21 | CONNECTOR, USB(A)         |
| 303     | 1-787-245-21 | FAN,DC                    |
| 304     | 2-187-200-03 | SHEET (CPU)               |
| 305     | 4-673-367-02 | THERMAL SHEET(CPU)        |
| 306     | A-1090-044-A | COMPLETE FPC FPC-13 (S)   |
| 307     | A-1090-047-A | COMPLETE FPC FPC-16 (S)   |
| 323     | 2-187-198-02 | COVER (FIN)               |
| 324     | 1-756-424-11 | BATTERY, VANADIUM-LITHIUM |
| 325     | 1-864-336-11 | PWB,FLEXIBLE              |
| 326     | 1-864-471-11 | PWB,FLEXIBLE              |
| 327     | 1-818-784-11 | CONNECTOR                 |
| 328     | 4-673-302-01 | ADHESIVE TAPE(RJ)         |
| 331     | 2-514-300-01 | CUSHION (SCREW)           |
| 332     | 2-514-301-01 | CUSHION (WLAN SLOT)       |
| 335     | 2-547-546-01 | CAUTION LABEL MEMORY L    |
| 336     | 2-187-373-01 | SPACER(FAN)               |
| 337     | 4-661-451-01 | ADHESIVE TAPE TOUCHPAD    |
| B7      | 4-672-834-31 | SCREW, +B EG GRIP         |
| B10     | 4-672-834-51 | SCREW, +B EG GRIP         |
| B11     | 4-672-834-91 | SCREW, +B EG GRIP         |

| Ref.No. | Part No.     | Description              | J      |        |        |        |        |                     |                                   |                                   |         |         | AM      |         |       |         |         | AO       |          |           |           |         |         |         |        |  |
|---------|--------------|--------------------------|--------|--------|--------|--------|--------|---------------------|-----------------------------------|-----------------------------------|---------|---------|---------|---------|-------|---------|---------|----------|----------|-----------|-----------|---------|---------|---------|--------|--|
|         |              |                          | T72B/L | T72B/T | T52B/L | T72P/Z | T92PS* | T92PS <sup>Y6</sup> | T92PSY <sup>6</sup><br>(28197404) | T92PSY <sup>6</sup><br>(28197405) | T370P/L | T350P/L | T350P/S | T350P/T | T350L | T360P/L | T340P/L | T330FP/L | T330FP/T | T370G/P/L | T370G/P/S | T377P/L | T377P/S | T36SP/S | T37C/L |  |
| 314     | A-1128-981-A | \$ # MBX-120(C10 2)-3(S) |        |        |        |        |        |                     |                                   |                                   |         |         |         |         |       |         |         |          |          |           |           |         |         |         |        |  |
| △[MA]   | A-1128-980-A | \$ # MBX-120(C10 5)-3(S) |        |        |        |        |        |                     |                                   |                                   |         |         |         |         |       |         |         |          |          |           |           |         |         |         |        |  |
|         | A-1128-976-A | \$ # MBX-120(P11 5)-3(S) |        |        |        |        |        |                     |                                   |                                   |         |         |         |         |       |         |         |          |          |           |           |         |         |         |        |  |
|         | A-1128-979-A | \$ # MBX-120(P12 2)-3(S) |        |        |        |        |        |                     |                                   |                                   |         |         |         |         |       |         |         |          |          |           |           |         |         |         |        |  |
|         | A-1128-978-A | \$ # MBX-120(P12 5)-3(S) |        |        |        |        |        |                     |                                   |                                   |         |         |         |         |       |         |         |          |          |           |           |         |         |         |        |  |
|         | 318          | 6-707-651-01             |        |        |        |        |        |                     |                                   |                                   |         |         |         |         |       |         |         |          |          |           |           |         |         |         |        |  |
| △[MA]   | 322          | 1-761-864-51             |        |        |        |        |        |                     |                                   |                                   |         |         |         |         |       |         |         |          |          |           |           |         |         |         |        |  |
|         |              | 1-761-864-61             |        |        |        |        |        |                     |                                   |                                   |         |         |         |         |       |         |         |          |          |           |           |         |         |         |        |  |
| △[MA]   |              | 1-761-864-71             |        |        |        |        |        |                     |                                   |                                   |         |         |         |         |       |         |         |          |          |           |           |         |         |         |        |  |
|         |              | 1-789-014-22             |        |        |        |        |        |                     |                                   |                                   |         |         |         |         |       |         |         |          |          |           |           |         |         |         |        |  |

- This parts list contains two different types of parts.  
The first type is the parts that are common to all models.  
The other type is the parts that are different depending on each model.
- As for the T92PSY, check the Product Code in a parenthesis which is written beside the model name, and select the parts to be used.  
Please refer to the page 4-2 for how to identify the Product Code.
- この部品表は、機種共通の部品と、機種によって使い分けが必要な部品に分かれています。
- T92PSYは機種名の横に記載されている、括弧内のProduct Codeを確認してから、使用する部品を選択してください。  
Product Codeの確認方法は4-2ページを参照してください。

B-1. Bottom

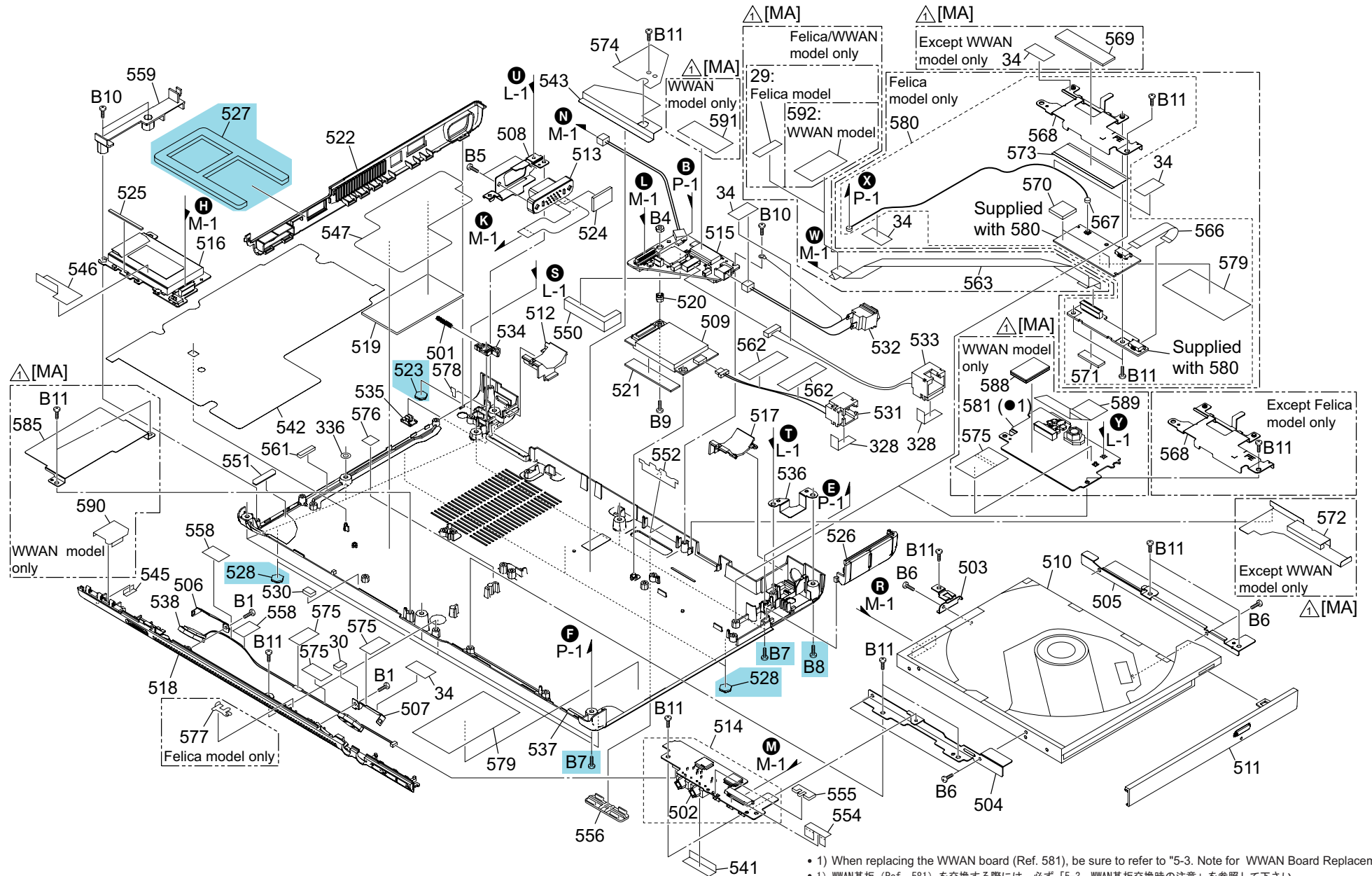

- 1) When replacing the WWAN board (Ref. 581), be sure to refer to "5-3. Note for WWAN Board Replacement".
- 1) WWAN基板 (Ref. 581) を交換する際には、必ず「5-3. WWAN基板交換時の注意」を参照して下さい。

Confidential

VGN-T52B/T72B/T72PZ/T92PS/T92PSY/T92S (J)  
 VGN-T330FP/T340P/T350/T350P/T360P/T370P (AM)  
 VGN-T36SP/T37C/T37GP/T37TP (AO)

B-1. Bottom

| Ref.No. | Part No.     | Description                    |
|---------|--------------|--------------------------------|
| 30      | 2-546-036-01 | GASKET (COVER HR)              |
| 34      | 4-658-789-02 | TAPE (HARNESS)                 |
| 328     | 4-673-302-01 | ADHESIVE TAPE(RJ)              |
| 336     | 2-187-373-01 | SPACER(FAN)                    |
| 501     | 4-672-723-01 | SPRING COMPRESSION COIL (A)    |
| 502     | 1-816-583-22 | JACK, SMALL TYPE               |
| 503     | 2-348-452-02 | BRACKET (OPC)                  |
| 504     | 2-159-889-01 | BRACKET (OPL)                  |
| 505     | 2-159-889-02 | BRACKET (OPR)                  |
| 506     | 2-159-893-02 | BRACKET (SPL)                  |
| 507     | 2-159-894-02 | BRACKET (SPR)                  |
| 508     | 2-159-881-02 | BRACKET (VGA)                  |
| 509     | 1-761-606-15 | # CARD, MODEM                  |
| 513     | A-1090-048-A | \$ COMPLETE FPC FPC-17 (S)     |
| 514     | A-1104-980-A | \$ CNX-270-2 (S)               |
| 515     | A-1134-116-A | \$ CNX-273-3(S)                |
| 516     | A-1128-982-A | \$ CNX-274-2(S)                |
| 519     | 2-190-700-02 | CUSHION (GMCH)                 |
| 520     | 2-159-865-01 | STAND                          |
| 521     | 2-582-513-02 | CUSHION (MDC2)                 |
| 523     | 4-670-189-11 | & CUSHION (UP)                 |
| 524     | 2-190-638-01 | CUSHION (VGA)                  |
| 525     | 2-349-374-01 | CUSHION (WLAN LED)             |
| 527     | 4-643-832-61 | & DUMMY CARD                   |
| 528     | 2-177-286-01 | & FOOT                         |
| 530     | 2-187-197-01 | GASKET (SP)                    |
| 531     | 1-962-037-21 | HARNESS (RJ11)                 |
| 532     | 1-963-317-11 | HARNESS WITH DC JACK 2P        |
| 533     | 1-963-259-31 | HARNESS, CONNECTOR WITH        |
| 534     | 2-159-879-02 | HOOK (BT)                      |
| 535     | 2-159-866-01 | KNOB (BT)                      |
| 536     | 2-177-444-01 | PLATE (PR), GROUND             |
| 538     | 1-825-972-11 | LOUDSPEAKER (1.6CM)            |
| 541     | 2-349-989-01 | SHEET (AUDIO)                  |
| 542     | 2-187-199-02 | SHEET (BT)                     |
| 543     | 2-590-981-01 | SHEET (MDC) 2                  |
| 545     | 2-349-376-01 | SHEET (WLAN LENS)              |
| 546     | 2-349-378-02 | SHEET (WLAN MS)                |
| 547     | 2-190-699-01 | SHEET GS                       |
| 550     | 2-548-777-02 | CUSHION (PT)                   |
| 551     | 2-514-961-01 | GASKET (MS)                    |
| 552     | 2-547-841-01 | SHEET (P)                      |
| 554     | 2-548-691-01 | TAPE (AUDIO)                   |
| 555     | 2-349-365-02 | CUSHION(SE)                    |
| 558     | -            | KAPTON TAPE (10X20)            |
| 559     | 2-159-861-05 | COVER (PCC)                    |
| 561     | 2-583-663-01 | GASKET (3X2X10)                |
| 562     | 4-677-810-11 | TAPE BTM                       |
| 574     | 2-590-982-02 | COVER (MDC)                    |
| 575     | 4-662-881-02 | CUSHION, KEY BOARD             |
| 576     | 2-586-963-01 | SPACER HARNESS (F)             |
| 578     | 2-592-081-01 | SPACER (HINGE)                 |
| 579     | 2-595-608-01 | SHEET (TB), INSULATING         |
| B1      | 4-676-936-01 | +SCREW O2 +SPECIAL HEAD SELF S |
| B4      | 4-673-751-01 | NUT (M2) (TYPE2)               |
| B5      | 4-674-716-01 | SCREW (NO.4-40) (UNC)          |
| B6      | 4-671-538-01 | SCREW(M2X4), SPECIAL HEAD      |
| B7      | 4-672-834-31 | & SCREW, +B EG GRIP            |
| B8      | 4-672-834-41 | & SCREW, +B EG GRIP            |
| B9      | 2-177-881-01 | +B2X8                          |
| B10     | 4-672-834-51 | SCREW, +B EG GRIP              |
| B11     | 4-672-834-91 | SCREW, +B EG GRIP              |

| Ref.No. | Part No.     | Description                              | T72B/L | T72B/T | T52B/L | T72P/Z | T92PS* | T92PS* | T92PS* | T92PS* | T92PS* | T370P/L | T350P/L | T350P/T | T350P/S | T350L | T360P/L | T340P/L | T330FP/L | T330FP/T | T370P/L | T370P/S | T377P/L | T377P/S | T36SP/S | T37C/L |
|---------|--------------|--|--------|--------|--------|--------|--------|--------|--------|--------|--------|---------|---------|---------|---------|-------|---------|---------|----------|----------|---------|---------|---------|---------|---------|--------|
| 29      | A-676-302-01 | TAPE (COMMON)                            |        |        |        |        |        |        |        |        |        |         |         |         |         |       |         |         |          |          |         |         |         |         |         |        |
| 510     | A-1104-117-A | \$ # COMBO DRIVE(UJDA765S)(S)            |        |        |        |        |        |        |        |        |        |         |         |         |         |       |         |         |          |          |         |         |         |         |         |        |
| 510     | A-1124-311-A | \$ # DVD-RW (UJ-832S 9.5MM) (S)          |        |        |        |        |        |        |        |        |        |         |         |         |         |       |         |         |          |          |         |         |         |         |         |        |
| 510     | A-1124-309-A | \$ # DVD-RWSM (UJ-832S 9.5MM) (S)        |        |        |        |        |        |        |        |        |        |         |         |         |         |       |         |         |          |          |         |         |         |         |         |        |
| 511     | X-2023-621-5 | BEZEL (C) (L) ASSY, OPT [Combo / Blue]   |        |        |        |        |        |        |        |        |        |         |         |         |         |       |         |         |          |          |         |         |         |         |         |        |
|         | X-2023-622-4 | BEZEL (C) (S) ASSY, OPT [Combo / Silver] |        |        |        |        |        |        |        |        |        |         |         |         |         |       |         |         |          |          |         |         |         |         |         |        |
|         | X-2023-623-5 | BEZEL (C) (T) ASSY, OPT [Combo / Brown]  |        |        |        |        |        |        |        |        |        |         |         |         |         |       |         |         |          |          |         |         |         |         |         |        |
|         | X-2055-789-1 | BEZEL (MD) (L) ASSY, OPT                 |        |        |        |        |        |        |        |        |        |         |         |         |         |       |         |         |          |          |         |         |         |         |         |        |
|         | X-2048-648-1 | BEZEL (C) (B) ASSY, OPT [Combo / Carbon] |        |        |        |        |        |        |        |        |        |         |         |         |         |       |         |         |          |          |         |         |         |         |         |        |
|         | X-2055-793-1 | BEZEL (MD) (S) ASSY, OPT                 |        |        |        |        |        |        |        |        |        |         |         |         |         |       |         |         |          |          |         |         |         |         |         |        |
|         | X-2055-791-1 | BEZEL (MD) (T) ASSY, OPT                 |        |        |        |        |        |        |        |        |        |         |         |         |         |       |         |         |          |          |         |         |         |         |         |        |
|         | X-2055-792-1 | BEZEL (MD) (B) ASSY, OPT                 |        |        |        |        |        |        |        |        |        |         |         |         |         |       |         |         |          |          |         |         |         |         |         |        |
|         | X-2055-793-1 | BEZEL (DD) (L) ASSY, OPT                 |        |        |        |        |        |        |        |        |        |         |         |         |         |       |         |         |          |          |         |         |         |         |         |        |
|         | X-2055-794-1 | BEZEL (DD) (S) ASSY, OPT                 |        |        |        |        |        |        |        |        |        |         |         |         |         |       |         |         |          |          |         |         |         |         |         |        |
|         | X-2059-570-1 | BEZEL (DD) (T) ASSY, OPT                 |        |        |        |        |        |        |        |        |        |         |         |         |         |       |         |         |          |          |         |         |         |         |         |        |
| 512     | 2-159-860-03 | COVER (L) [Blue]                         |        |        |        |        |        |        |        |        |        |         |         |         |         |       |         |         |          |          |         |         |         |         |         |        |
|         | 2-159-860-13 | COVER (L) [Silver]                       |        |        |        |        |        |        |        |        |        |         |         |         |         |       |         |         |          |          |         |         |         |         |         |        |
|         | 2-159-860-23 | COVER (L) [Brown]                        |        |        |        |        |        |        |        |        |        |         |         |         |         |       |         |         |          |          |         |         |         |         |         |        |
|         | 2-159-860-32 | COVER (L) [Carbon]                       |        |        |        |        |        |        |        |        |        |         |         |         |         |       |         |         |          |          |         |         |         |         |         |        |
| 517     | 2-159-862-02 | COVER (R) [Blue]                         |        |        |        |        |        |        |        |        |        |         |         |         |         |       |         |         |          |          |         |         |         |         |         |        |
|         | 2-159-862-12 | COVER (R) [Silver]                       |        |        |        |        |        |        |        |        |        |         |         |         |         |       |         |         |          |          |         |         |         |         |         |        |
|         | 2-159-862-22 | COVER (R) [Brown]                        |        |        |        |        |        |        |        |        |        |         |         |         |         |       |         |         |          |          |         |         |         |         |         |        |
|         | 2-159-862-31 | COVER (R) [Carbon]                       |        |        |        |        |        |        |        |        |        |         |         |         |         |       |         |         |          |          |         |         |         |         |         |        |
| 518     | X-2022-972-4 | ESLUTCHEON (FR) (L) ASSY [Blue]          |        |        |        |        |        |        |        |        |        |         |         |         |         |       |         |         |          |          |         |         |         |         |         |        |
|         | X-2023-624-3 | ESLUTCHEON (FR) (S) ASSY [Silver]        |        |        |        |        |        |        |        |        |        |         |         |         |         |       |         |         |          |          |         |         |         |         |         |        |
|         | X-2023-625-4 | ESLUTCHEON (FR) (T) ASSY [Brown]         |        |        |        |        |        |        |        |        |        |         |         |         |         |       |         |         |          |          |         |         |         |         |         |        |
|         | X-2048-644-1 | ESLUTCHEON (FR) (B) ASSY [Carbon]        |        |        |        |        |        |        |        |        |        |         |         |         |         |       |         |         |          |          |         |         |         |         |         |        |
| 522     | 2-159-858-04 | ESLUTCHEON (L) [Blue]                    |        |        |        |        |        |        |        |        |        |         |         |         |         |       |         |         |          |          |         |         |         |         |         |        |
|         | 2-159-858-13 | ESLUTCHEON (L) [Silver]                  |        |        |        |        |        |        |        |        |        |         |         |         |         |       |         |         |          |          |         |         |         |         |         |        |
|         | 2-159-858-24 | ESLUTCHEON (L) [Brown]                   |        |        |        |        |        |        |        |        |        |         |         |         |         |       |         |         |          |          |         |         |         |         |         |        |
|         | 2-159-858-31 | ESLUTCHEON (L) [Carbon]                  |        |        |        |        |        |        |        |        |        |         |         |         |         |       |         |         |          |          |         |         |         |         |         |        |
| 526     | X-2023-099-2 | ESLUTCHEON (R) (L) ASSY [Blue]           |        |        |        |        |        |        |        |        |        |         |         |         |         |       |         |         |          |          |         |         |         |         |         |        |
|         | X-2023-617-2 | ESLUTCHEON (R) (S) ASSY [Silver]         |        |        |        |        |        |        |        |        |        |         |         |         |         |       |         |         |          |          |         |         |         |         |         |        |
|         | X-2023-618-2 | ESLUTCHEON (R) (T) ASSY [Brown]          |        |        |        |        |        |        |        |        |        |         |         |         |         |       |         |         |          |          |         |         |         |         |         |        |
|         | X-2048-645-1 | ESLUTCHEON (R) (B) ASSY [Carbon]         |        |        |        |        |        |        |        |        |        |         |         |         |         |       |         |         |          |          |         |         |         |         |         |        |
| 537     | 2-159-878-03 | HOUSING (BOTTOM) (K1) [Blue]             |        |        |        |        |        |        |        |        |        |         |         |         |         |       |         |         |          |          |         |         |         |         |         |        |
|         | 2-159-878-13 | HOUSING (BOTTOM) (K1) [Silver]           |        |        |        |        |        |        |        |        |        |         |         |         |         |       |         |         |          |          |         |         |         |         |         |        |
|         | 2-159-878-23 | HOUSING (BOTTOM) (K1) [Brown]            |        |        |        |        |        |        |        |        |        |         |         |         |         |       |         |         |          |          |         |         |         |         |         |        |
|         | 2-159-878-32 | HOUSING (BOTTOM) (K1) [Carbon]           |        |        |        |        |        |        |        |        |        |         |         |         |         |       |         |         |          |          |         |         |         |         |         |        |
| 556     | 2-514-604-01 | CAP (PR)                                 |        |        |        |        |        |        |        |        |        |         |         |         |         |       |         |         |          |          |         |         |         |         |         |        |
|         | 2-514-604-11 | CAP (PR)                                 |        |        |        |        |        |        |        |        |        |         |         |         |         |       |         |         |          |          |         |         |         |         |         |        |
| 563     | 1-830-336-12 | CABLE FLEXIBLE FLAT (RF)                 |        |        |        |        |        |        |        |        |        |         |         |         |         |       |         |         |          |          |         |         |         |         |         |        |
|         | 1-830-403-11 | CABLE FLEXIBLE FLAT (24P)                |        |        |        |        |        |        |        |        |        |         |         |         |         |       |         |         |          |          |         |         |         |         |         |        |
| 566     | 1-830-303-11 | CABLE FLEXIBLE FLAT (PWS48)              |        |        |        |        |        |        |        |        |        |         |         |         |         |       |         |         |          |          |         |         |         |         |         |        |
| 567     | 1-830-396-11 | CABLE COAXIAL (WITH U.FL 1.32)           |        |        |        |        |        |        |        |        |        |         |         |         |         |       |         |         |          |          |         |         |         |         |         |        |
| 568     | 2-580-560-02 | BRACKET RF BOARD (F)                     |        |        |        |        |        |        |        |        |        |         |         |         |         |       |         |         |          |          |         |         |         |         |         |        |
| 569     | 2-580-561-01 | SPACER OP (F)                            |        |        |        |        |        |        |        |        |        |         |         |         |         |       |         |         |          |          |         |         |         |         |         |        |
| 570     | 2-580-562-01 | CUSHION RF BOARD (F)                     |        |        |        |        |        |        |        |        |        |         |         |         |         |       |         |         |          |          |         |         |         |         |         |        |
| 571     | 2-580-563-01 | CUSHION TRANCE BOARD (F)                 |        |        |        |        |        |        |        |        |        |         |         |         |         |       |         |         |          |          |         |         |         |         |         |        |
| 572     | 2-580-565-02 | SHEET TRANCE BOARD (F)                   |        |        |        |        |        |        |        |        |        |         |         |         |         |       |         |         |          |          |         |         |         |         |         |        |
| 573     | 2-585-727-01 | SHEET RF BOARD                           |        |        |        |        |        |        |        |        |        |         |         |         |         |       |         |         |          |          |         |         |         |         |         |        |
| 577     | 2-586-962-02 | SHEET HARNESS (F)                        |        |        |        |        |        |        |        |        |        |         |         |         |         |       |         |         |          |          |         |         |         |         |         |        |
| 580     | A-1118-330-A | \$ RW MODULE ASSY(S)                     |        |        |        |        |        |        |        |        |        |         |         |         |         |       |         |         |          |          |         |         |         |         |         |        |
| 581     | A-1132-387-A | \$ GPRS UNIT(S)                          |        |        |        |        |        |        |        |        |        |         |         |         |         |       |         |         |          |          |         |         |         |         |         |        |
| 585     | 2-597-633-01 | SHIELD PLATE(WLAN)                       |        |        |        |        |        |        |        |        |        |         |         |         |         |       |         |         |          |          |         |         |         |         |         |        |
| 588     | 2-630-033-01 | SPACER OP (G)                            |        |        |        |        |        |        |        |        |        |         |         |         |         |       |         |         |          |          |         |         |         |         |         |        |
| 589     | 2-633-193-01 | SHEET (G)                                |        |        |        |        |        |        |        |        |        |         |         |         |         |       |         |         |          |          |         |         |         |         |         |        |
| 590     | 2-634-410-01 | COVER (LED) (W)                          |        |        |        |        |        |        |        |        |        |         |         |         |         |       |         |         |          |          |         |         |         |         |         |        |
| 591     | 4-657-250-01 | CUSHION INV 15                           |        |        |        |        |        |        |        |        |        |         |         |         |         |       |         |         |          |          |         |         |         |         |         |        |
| 592     | 2-638-119-01 | SHEET(30X50)                             |        |        |        |        |        |        |        |        |        |         |         |         |         |       |         |         |          |          |         |         |         |         |         |        |

• This parts list contains two different types of parts.  
 The first type is the parts that are common to all models.  
 The other type is the parts that are different depending on each model.  
 • As for the T92PSY, check the Product Code in a parenthesis which is written beside the model name, and select the parts to be used.  
 Please refer to the page 4-2 for how to identify the Product Code.

• この部品表は、機種共通の部品と、機種によって使い分けが必要な部品に分かれています。  
 • T92PSYは機種名の横に記載されている、括弧内のProduct Codeを確認してから、使用する部品を選択してください。  
 Product Codeの確認方法は4-2ページを参照してください。

• 1) When replacing the WWAN board (Ref. 581), be sure to refer to "5-3. Note for WWAN Board Replacement".  
 • 1) WWAN基板 (Ref. 581) を交換する際には、必ず「5-3. WWAN基板交換時の注意」を参照して下さい。

Confidential

VGN-T52B/T72B/T72PZ/T92PS/T92S (J)  
 VGN-T330FP/T340P/T350/T350P/T360P/T370P (AM)  
 VGN-T36SP/T37C/T37GP/T37TP (AO)



# H-1. HDD

## Type Hi

| Ref.No. | Part No.     | Description             |
|---------|--------------|-------------------------|
| 34      | 4-658-789-02 | TAPE (HARNES)           |
| 331     | 2-514-300-01 | CUSHION (SCREW)         |
| * 901   | 2-159-885-01 | BRACKET (HDDHIF)        |
| * 902   | 2-159-886-01 | BRACKET (HDDHIR)        |
| 903     | A-1090-046-A | COMPLETE FPC FPC-15 (S) |
| 904     | 2-514-299-01 | CUSHION (HDDHI F)       |
| 905     | 2-349-373-01 | CUSHION (HDDHI)         |
| 906     | 2-349-372-02 | SHEET (HDDHI)           |
| B3      | 4-679-325-01 | PS SCREW M2.5           |
| B10     | 4-672-834-51 | SCREW, +B EG GRIP       |

| Ref.No. | Part No. | Description  | J                      |        |                                | AM    |        |        |                       |                       |         |         |         |         |        | AO      |          |          |         |         |         |         |        |  |  |  |  |
|---------|----------|--------------|------------------------|--------|--------------------------------|-------|--------|--------|-----------------------|-----------------------|---------|---------|---------|---------|--------|---------|----------|----------|---------|---------|---------|---------|--------|--|--|--|--|
|         |          |              | T72B/L                 | T72B/T | T52B/L                         | T72PZ | T92PS* | T92PS* | T92PSY*<br>(28197404) | T92PSY*<br>(28197405) | T370P/L | T350P/L | T350P/S | T350P/T | T350/L | T340P/L | T330FP/L | T330FP/T | T37GP/L | T37GP/S | T37TP/L | T36SP/S | T37C/L |  |  |  |  |
| △ [MA]  | 30       | 2-546-036-01 | GASKET (COVER HR)      |        |                                |       |        |        |                       |                       |         |         |         |         |        |         |          |          |         |         |         |         |        |  |  |  |  |
|         | 908      | A-1121-709-A | \$                     | #      | HDD (40GB,HTC426040G9A100) (S) |       |        |        |                       |                       |         |         |         |         |        |         |          |          |         |         |         |         |        |  |  |  |  |
|         |          | A-1104-118-A | \$                     | #      | HDD (60GB,HTC426060G9A100) (S) |       |        |        |                       |                       |         |         |         |         |        |         |          |          |         |         |         |         |        |  |  |  |  |
| △ [MA]  | 909      | 2-629-382-01 | DOUBLE STICK TAPE WLAN |        |                                |       |        |        |                       |                       |         |         |         |         |        |         |          |          |         |         |         |         |        |  |  |  |  |

- This parts list contains two different types of parts. The first type is the parts that are common to all models. The other type is the parts that are different depending on each model.
- As for the T92PSY, check the Product Code in a parenthesis which is written beside the model name, and select the parts to be used. Please refer to the page 4-2 for how to identify the Product Code.
- この部品表は、機種共通の部品と、機種によって使い分けが必要な部品に分かれています。
- T92PSYは機種名の横に記載されている、括弧内のProduct Codeを確認してから、使用する部品を選択してください。Product Codeの確認方法は4-2ページを参照してください。

## Type To

| Ref.No. | Part No.     | Description             |
|---------|--------------|-------------------------|
| 29      | 4-676-302-01 | TAPE (COMMON)           |
| 331     | 2-514-300-01 | CUSHION (SCREW)         |
| * 921   | 2-159-887-01 | BRACKET (HDDTO)         |
| 922     | A-1090-045-A | COMPLETE FPC FPC-14 (S) |
| 923     | 2-159-884-01 | CUSHION (HDD)           |
| 924     | 2-349-371-03 | SHEET (HDDTO)           |
| 925     | 2-584-053-01 | GASKET (5X2X35)         |
| B10     | 4-672-834-51 | SCREW, +B EG GRIP       |

| Ref.No. | Part No. | Description  | J                      |        |                         | AM    |        |                       |                       |         |         |         |         |        |         | AO       |          |         |         |         |         |        |  |  |  |  |  |
|---------|----------|--------------|------------------------|--------|-------------------------|-------|--------|-----------------------|-----------------------|---------|---------|---------|---------|--------|---------|----------|----------|---------|---------|---------|---------|--------|--|--|--|--|--|
|         |          |              | T72B/L                 | T72B/T | T52B/L                  | T72PZ | T92PS* | T92PSY*<br>(28197404) | T92PSY*<br>(28197405) | T370P/L | T350P/L | T350P/S | T350P/T | T350/L | T340P/L | T330FP/L | T330FP/T | T37GP/L | T37GP/S | T37TP/L | T36SP/S | T37C/L |  |  |  |  |  |
| △ [MA]  | 909      | 2-629-382-01 | DOUBLE STICK TAPE WLAN |        |                         |       |        |                       |                       |         |         |         |         |        |         |          |          |         |         |         |         |        |  |  |  |  |  |
|         | 926      | A-1104-112-A | \$                     | #      | HDD(MK4006GAH-40GB) (S) |       |        |                       |                       |         |         |         |         |        |         |          |          |         |         |         |         |        |  |  |  |  |  |
|         |          | A-1104-113-A | \$                     | #      | HDD(MK6006GAH-60GB) (S) |       |        |                       |                       |         |         |         |         |        |         |          |          |         |         |         |         |        |  |  |  |  |  |
| △ [MA]  | 927      | 2-633-945-01 | GASKET (4X3.5X20)      |        |                         |       |        |                       |                       |         |         |         |         |        |         |          |          |         |         |         |         |        |  |  |  |  |  |

- This parts list contains two different types of parts. The first type is the parts that are common to all models. The other type is the parts that are different depending on each model.
- As for the T92PSY, check the Product Code in a parenthesis which is written beside the model name, and select the parts to be used. Please refer to the page 4-2 for how to identify the Product Code.
- この部品表は、機種共通の部品と、機種によって使い分けが必要な部品に分かれています。
- T92PSYは機種名の横に記載されている、括弧内のProduct Codeを確認してから、使用する部品を選択してください。Product Codeの確認方法は4-2ページを参照してください。

# L-1. LCD 10.6-inch TFT WXGA (Brightness)

— Made by SH —

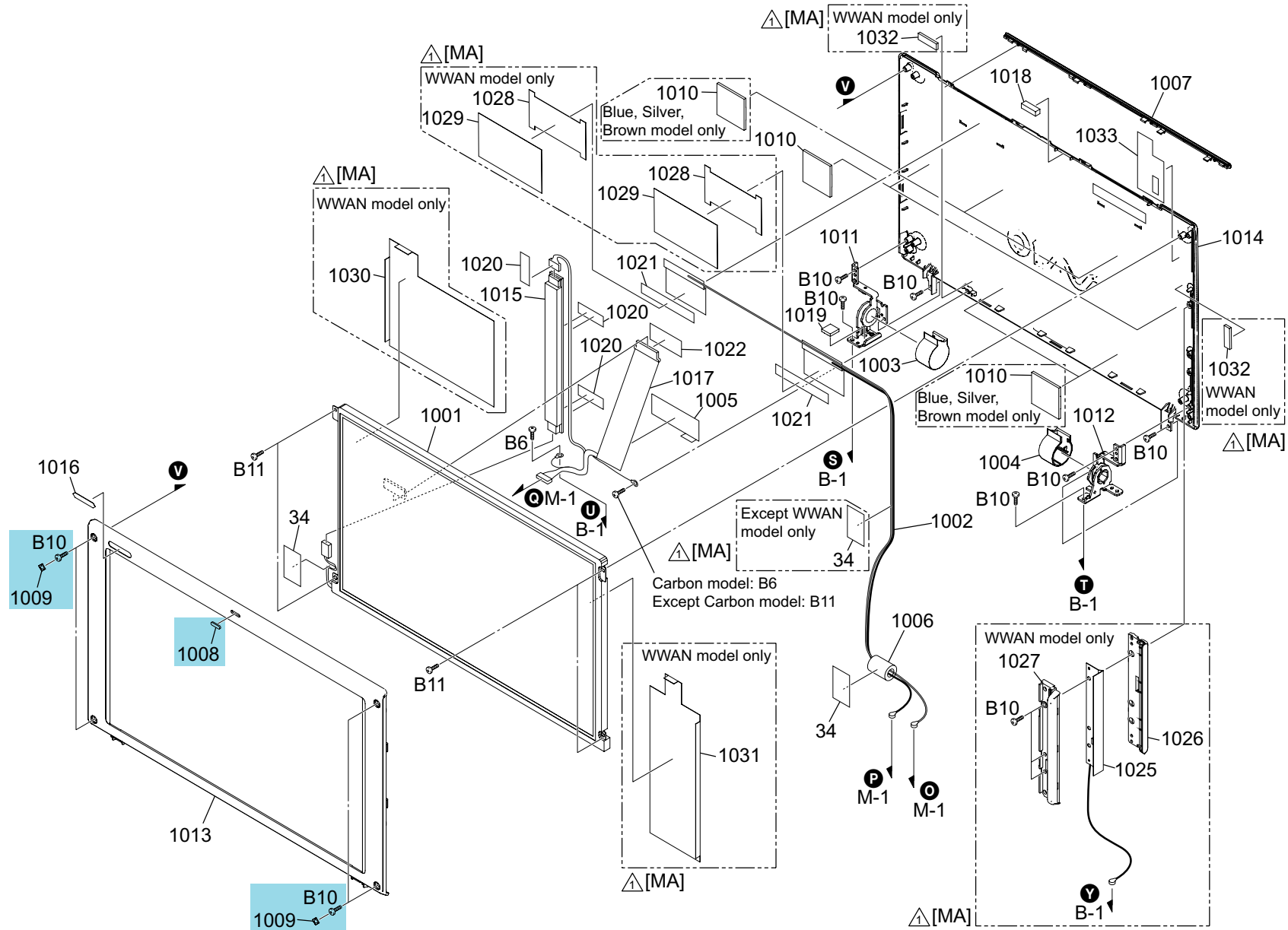

Confidential

VGN-T52B/T72B/T72PZ/T92PS/T92PSY/T92S (J)  
VGN-T330FP/T340P/T350/T350P/T360P/T370P (AM)  
VGN-T36SP/T37C/T37GP/T37TP (AO)

# L-1. LCD 10.6-inch TFT WXGA (Brightness)

— Made by SH —

| Ref.No. | Part No.     | Description                   |
|---------|--------------|-------------------------------|
| 34      | 4-658-789-02 | TAPE (HARNESS)                |
| 1001    | A-8068-213-A | LCD (UNIT) (10.6TFT WXGA) (S) |
| 1003    | 2-159-824-02 | CAP (L)                       |
| 1004    | 2-159-825-02 | CAP (R)                       |
| 1005    | 2-348-101-01 | COPPER TAPE (LCD)             |
| 1006    | 1-500-847-11 | CORE,FERRITE                  |
| 1008    | 4-670-190-11 | CUSHION (SIDE)                |
| 1009    | 2-178-223-01 | CUSHION BZ                    |
| 1010    | 2-188-040-01 | CUSHION LCD                   |
| 1011    | 2-159-830-01 | HINGE (L)                     |
| 1012    | 2-159-831-01 | HINGE (R)                     |
| 1013    | 2-159-829-03 | HOUSING (BEZEL)               |
| 1015    | 1-479-155-21 | INVERTER UNIT                 |
| 1017    | 1-963-100-12 | LCD HARNESS                   |
| 1018    | 2-159-832-01 | MAGNET                        |
| 1019    | 2-349-775-01 | CUSHION (HINGE L)             |
| 1020    | -            | KAPTON TAPE (10X40)           |
| 1021    | -            | FILAMENT TAPE (12X55)         |
| 1022    | -            | FILAMENT TAPE (9X30)          |
| 1033    | 2-629-983-01 | SPACER LCD2                   |
| B6      | 4-671-538-01 | SCREW(M2X4), SPECIAL HEAD     |
| B10     | 4-672-834-51 | SCREW, +B EG GRIP             |
| B11     | 4-672-834-91 | SCREW, +B EG GRIP             |

| Ref.No. | Part No. | Description  | T72B/L                              | T72B/T | T59B/L | T72PZ | T92PS* | T92S* | T92PSY*<br>(28197404) | T92PSY*<br>(28197405) | T370P/L | T350P/L | T350P/T | T350L | T360P/L | T340P/L | T330FP/L | T370P/T | T37GP/S | T37TP/L | T37TP/S | T36SP/S | T37C/L |   |
|---------|----------|--------------|-------------------------------------|--------|--------|-------|--------|-------|-----------------------|-----------------------|---------|---------|---------|-------|---------|---------|----------|---------|---------|---------|---------|---------|--------|---|
| △(MA)   | 1002     | 1-754-353-51 | ANTENNA.FILM                        | ●      | ●      | ●     | ●      | ●     | ●                     | ●                     | ●       | ●       | ●       | ●     | ●       | ●       | ●        | ●       | ●       | ●       | ●       | ●       | ●      | ● |
|         |          | 1-754-353-61 | ANTENNA.FILM                        | ●      | ●      | ●     | ●      | ●     | ●                     | ●                     | ●       | ●       | ●       | ●     | ●       | ●       | ●        | ●       | ●       | ●       | ●       | ●       | ●      | ● |
|         | 1007     | 2-159-826-02 | COVER (WLAN) [Blue]                 | ●      | ●      | ●     | ●      | ●     | ●                     | ●                     | ●       | ●       | ●       | ●     | ●       | ●       | ●        | ●       | ●       | ●       | ●       | ●       | ●      | ● |
|         |          | 2-159-826-11 | COVER (WLAN) [Silver]               | ●      | ●      | ●     | ●      | ●     | ●                     | ●                     | ●       | ●       | ●       | ●     | ●       | ●       | ●        | ●       | ●       | ●       | ●       | ●       | ●      | ● |
|         |          | 2-159-826-22 | COVER (WLAN) [Brown]                | ●      | ●      | ●     | ●      | ●     | ●                     | ●                     | ●       | ●       | ●       | ●     | ●       | ●       | ●        | ●       | ●       | ●       | ●       | ●       | ●      | ● |
|         |          | 2-159-826-31 | COVER (WLAN) [Carbon]               | ●      | ●      | ●     | ●      | ●     | ●                     | ●                     | ●       | ●       | ●       | ●     | ●       | ●       | ●        | ●       | ●       | ●       | ●       | ●       | ●      | ● |
|         | 1014     | A-1090-054-A | DISPLAY (BL) LOGO ASSY (S) [Blue]   | ●      | ●      | ●     | ●      | ●     | ●                     | ●                     | ●       | ●       | ●       | ●     | ●       | ●       | ●        | ●       | ●       | ●       | ●       | ●       | ●      | ● |
|         |          | A-1090-056-A | DISPLAY (SI) LOGO ASSY (S) [Silver] | ●      | ●      | ●     | ●      | ●     | ●                     | ●                     | ●       | ●       | ●       | ●     | ●       | ●       | ●        | ●       | ●       | ●       | ●       | ●       | ●      | ● |
|         |          | A-1090-058-A | DISPLAY (BR) LOGO ASSY (S) [Brown]  | ●      | ●      | ●     | ●      | ●     | ●                     | ●                     | ●       | ●       | ●       | ●     | ●       | ●       | ●        | ●       | ●       | ●       | ●       | ●       | ●      | ● |
|         |          | A-1104-063-A | DISPLAY (CA) LOGO ASSY (S) [Carbon] | ●      | ●      | ●     | ●      | ●     | ●                     | ●                     | ●       | ●       | ●       | ●     | ●       | ●       | ●        | ●       | ●       | ●       | ●       | ●       | ●      | ● |
| △(MA)   |          | A-1137-661-A | DISPLAY (BL) (US) ASSY (S) [Blue]   | ●      | ●      | ●     | ●      | ●     | ●                     | ●                     | ●       | ●       | ●       | ●     | ●       | ●       | ●        | ●       | ●       | ●       | ●       | ●       | ●      | ● |
| △(MA)   |          | A-1137-662-A | DISPLAY (SI) (US) ASSY (S) [Silver] | ●      | ●      | ●     | ●      | ●     | ●                     | ●                     | ●       | ●       | ●       | ●     | ●       | ●       | ●        | ●       | ●       | ●       | ●       | ●       | ●      | ● |
| △(MA)   |          | A-1137-663-A | DISPLAY (BR) (US) ASSY (S) [Brown]  | ●      | ●      | ●     | ●      | ●     | ●                     | ●                     | ●       | ●       | ●       | ●     | ●       | ●       | ●        | ●       | ●       | ●       | ●       | ●       | ●      | ● |
|         |          | A-1137-664-A | DISPLAY (CA) (US) ASSY (S) [Carbon] | ●      | ●      | ●     | ●      | ●     | ●                     | ●                     | ●       | ●       | ●       | ●     | ●       | ●       | ●        | ●       | ●       | ●       | ●       | ●       | ●      | ● |
| △(MA)   | 1016     | 2-598-788-01 | LABEL (ID)                          | ●      | ●      | ●     | ●      | ●     | ●                     | ●                     | ●       | ●       | ●       | ●     | ●       | ●       | ●        | ●       | ●       | ●       | ●       | ●       | ●      | ● |
|         |          | 2-598-788-11 | LABEL (ID)                          | ●      | ●      | ●     | ●      | ●     | ●                     | ●                     | ●       | ●       | ●       | ●     | ●       | ●       | ●        | ●       | ●       | ●       | ●       | ●       | ●      | ● |
| △(MA)   |          | 2-598-788-21 | LABEL (ID)                          | ●      | ●      | ●     | ●      | ●     | ●                     | ●                     | ●       | ●       | ●       | ●     | ●       | ●       | ●        | ●       | ●       | ●       | ●       | ●       | ●      | ● |
|         |          | 2-598-788-31 | LABEL (ID)                          | ●      | ●      | ●     | ●      | ●     | ●                     | ●                     | ●       | ●       | ●       | ●     | ●       | ●       | ●        | ●       | ●       | ●       | ●       | ●       | ●      | ● |
|         |          | 2-598-788-41 | LABEL (ID)                          | ●      | ●      | ●     | ●      | ●     | ●                     | ●                     | ●       | ●       | ●       | ●     | ●       | ●       | ●        | ●       | ●       | ●       | ●       | ●       | ●      | ● |
|         |          | 2-598-788-51 | LABEL (ID)                          | ●      | ●      | ●     | ●      | ●     | ●                     | ●                     | ●       | ●       | ●       | ●     | ●       | ●       | ●        | ●       | ●       | ●       | ●       | ●       | ●      | ● |
| △(MA)   |          | 2-598-820-01 | LABEL (ID)                          | ●      | ●      | ●     | ●      | ●     | ●                     | ●                     | ●       | ●       | ●       | ●     | ●       | ●       | ●        | ●       | ●       | ●       | ●       | ●       | ●      | ● |
| △(MA)   |          | 2-598-820-11 | LABEL (ID)                          | ●      | ●      | ●     | ●      | ●     | ●                     | ●                     | ●       | ●       | ●       | ●     | ●       | ●       | ●        | ●       | ●       | ●       | ●       | ●       | ●      | ● |
| △(MA)   |          | 2-598-820-21 | LABEL (ID)                          | ●      | ●      | ●     | ●      | ●     | ●                     | ●                     | ●       | ●       | ●       | ●     | ●       | ●       | ●        | ●       | ●       | ●       | ●       | ●       | ●      | ● |
| △(MA)   |          | 2-598-820-31 | LABEL (ID)                          | ●      | ●      | ●     | ●      | ●     | ●                     | ●                     | ●       | ●       | ●       | ●     | ●       | ●       | ●        | ●       | ●       | ●       | ●       | ●       | ●      | ● |
| △(MA)   |          | 2-598-820-41 | LABEL (ID)                          | ●      | ●      | ●     | ●      | ●     | ●                     | ●                     | ●       | ●       | ●       | ●     | ●       | ●       | ●        | ●       | ●       | ●       | ●       | ●       | ●      | ● |
| △(MA)   |          | 2-598-820-51 | LABEL (ID)                          | ●      | ●      | ●     | ●      | ●     | ●                     | ●                     | ●       | ●       | ●       | ●     | ●       | ●       | ●        | ●       | ●       | ●       | ●       | ●       | ●      | ● |
| △(MA)   |          | 2-598-916-01 | LABEL (ID)                          | ●      | ●      | ●     | ●      | ●     | ●                     | ●                     | ●       | ●       | ●       | ●     | ●       | ●       | ●        | ●       | ●       | ●       | ●       | ●       | ●      | ● |
| △(MA)   |          | 2-598-916-11 | LABEL (ID)                          | ●      | ●      | ●     | ●      | ●     | ●                     | ●                     | ●       | ●       | ●       | ●     | ●       | ●       | ●        | ●       | ●       | ●       | ●       | ●       | ●      | ● |
| △(MA)   |          | 2-598-916-21 | LABEL (ID)                          | ●      | ●      | ●     | ●      | ●     | ●                     | ●                     | ●       | ●       | ●       | ●     | ●       | ●       | ●        | ●       | ●       | ●       | ●       | ●       | ●      | ● |
| △(MA)   |          | 2-598-933-01 | LABEL (ID)                          | ●      | ●      | ●     | ●      | ●     | ●                     | ●                     | ●       | ●       | ●       | ●     | ●       | ●       | ●        | ●       | ●       | ●       | ●       | ●       | ●      | ● |
| △(MA)   | 1025     | 1-754-387-11 | WAN ANTENNA.FILM                    | ●      | ●      | ●     | ●      | ●     | ●                     | ●                     | ●       | ●       | ●       | ●     | ●       | ●       | ●        | ●       | ●       | ●       | ●       | ●       | ●      | ● |
| △(MA)   | 1026     | 2-549-386-01 | COVER ANT LO                        | ●      | ●      | ●     | ●      | ●     | ●                     | ●                     | ●       | ●       | ●       | ●     | ●       | ●       | ●        | ●       | ●       | ●       | ●       | ●       | ●      | ● |
| △(MA)   | 1027     | 2-549-387-01 | COVER ANT UP                        | ●      | ●      | ●     | ●      | ●     | ●                     | ●                     | ●       | ●       | ●       | ●     | ●       | ●       | ●        | ●       | ●       | ●       | ●       | ●       | ●      | ● |
| △(MA)   | 1028     | 2-595-180-01 | SHIELD TAPE WLAN                    | ●      | ●      | ●     | ●      | ●     | ●                     | ●                     | ●       | ●       | ●       | ●     | ●       | ●       | ●        | ●       | ●       | ●       | ●       | ●       | ●      | ● |
| △(MA)   | 1029     | 2-595-181-01 | INSULATING SHEET WLAN               | ●      | ●      | ●     | ●      | ●     | ●                     | ●                     | ●       | ●       | ●       | ●     | ●       | ●       | ●        | ●       | ●       | ●       | ●       | ●       | ●      | ● |
| △(MA)   | 1030     | 2-595-182-01 | SHIELD TAPE LCD L                   | ●      | ●      | ●     | ●      | ●     | ●                     | ●                     | ●       | ●       | ●       | ●     | ●       | ●       | ●        | ●       | ●       | ●       | ●       | ●       | ●      | ● |
| △(MA)   | 1031     | 2-595-183-01 | SHIELD TAPE LCD R                   | ●      | ●      | ●     | ●      | ●     | ●                     | ●                     | ●       | ●       | ●       | ●     | ●       | ●       | ●        | ●       | ●       | ●       | ●       | ●       | ●      | ● |
| △(MA)   | 1032     | 2-629-381-01 | GASKET (15X4X2)                     | ●      | ●      | ●     | ●      | ●     | ●                     | ●                     | ●       | ●       | ●       | ●     | ●       | ●       | ●        | ●       | ●       | ●       | ●       | ●       | ●      | ● |

- This parts list contains two different types of parts.  
The first type is the parts that are common to all models.  
The other type is the parts that are different depending on each model.
- As for the T92PSY, check the Product Code in a parenthesis which is written beside the model name, and select the parts to be used.  
Please refer to the page 4-2 for how to identify the Product Code.

- この部品表は、機種共通の部品と、機種によって使い分けが必要な部品に分かれています。
- T92PSYは機種名の横に記載されている、括弧内のProduct Codeを確認してから、使用する部品を選択してください。  
Product Codeの確認方法は4-2ページを参照してください。

A-1. Accessories

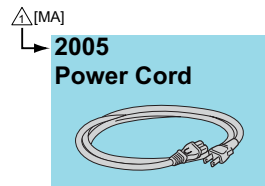
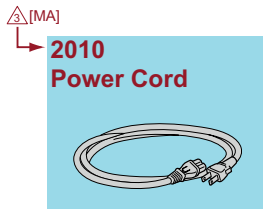
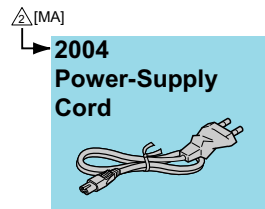
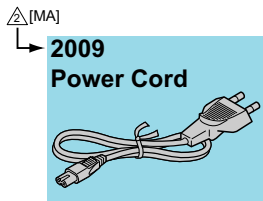
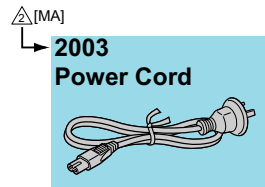
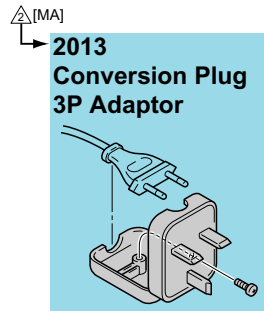
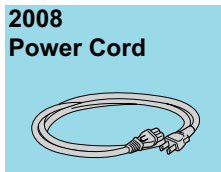
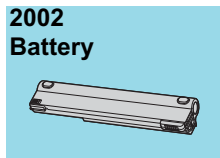
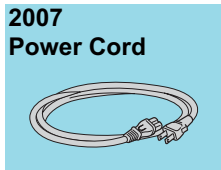

| Ref.No. | Part No.            | Description  | T72B/L | T72B/T | T92B/L | T72PZ | T92PS* | T92PSY-<br>(28187404) | T92PSY-<br>(28187405) | T370P/L | T360P/L | T350P/S | T350P/T | T360/L | T360P/L | T340P/L | T330P/T | T37GP/L | T37GP/S | T37TP/S | T36SP/S | T37C/L |   |
|---------|---------------------|--|--------|--------|--------|-------|--------|-----------------------|-----------------------|---------|---------|---------|---------|--------|---------|---------|---------|---------|---------|---------|---------|--------|---|
| △ [MA]  | △ 2001 1-478-583-22 | & AC ADAPTOR   | ●      | ●      | ●      | ●     | ●      | ●                     | ●                     | ●       | ●       | ●       | ●       | ●      | ●       | ●       | ●       | ●       | ●       | ●       | ●       | ●      | ● |
| △ [MA]  | △ 2001 1-478-960-22 | & ADAPTOR  | ●      | ●      | ●      | ●     | ●      | ●                     | ●                     | ●       | ●       | ●       | ●       | ●      | ●       | ●       | ●       | ●       | ●       | ●       | ●       | ●      | ● |
| △ [MA]  | △ 2002 A-1110-268-A | & BATTERY PACK LITHIUM ION(U) (S)                                    | ●      | ●      | ●      | ●     | ●      | ●                     | ●                     | ●       | ●       | ●       | ●       | ●      | ●       | ●       | ●       | ●       | ●       | ●       | ●       | ●      | ● |
| △ [MA]  | △ 2002 A-1110-269-A | & BATTERY PACK LITHIUM ION(U) (S)                                    | ●      | ●      | ●      | ●     | ●      | ●                     | ●                     | ●       | ●       | ●       | ●       | ●      | ●       | ●       | ●       | ●       | ●       | ●       | ●       | ●      | ● |
| △ [MA]  | △ 2002 A-1110-270-A | & BATTERY PACK LITHIUM ION(E) (S)                                    | ●      | ●      | ●      | ●     | ●      | ●                     | ●                     | ●       | ●       | ●       | ●       | ●      | ●       | ●       | ●       | ●       | ●       | ●       | ●       | ●      | ● |
| △ [MA]  | △ 2003 1-555-074-32 | & CORD, POWER  |        |        |        |       |        |                       |                       |         |         |         |         |        |         |         |         |         |         |         |         |        |   |
| △ [MA]  | △ 2004 1-827-481-21 | & POWER-SUPPLY CORD  |        |        |        |       |        |                       |                       |         |         |         |         |        |         |         |         |         |         |         |         |        |   |
| △ [MA]  | △ 2005 1-829-237-21 | & CORD, POWER  |        |        |        |       |        |                       |                       |         |         |         |         |        |         |         |         |         |         |         |         |        |   |
| △ [MA]  | △ 2007 1-827-160-21 | & POWER-SUPPLY CORD  |        |        |        |       |        |                       |                       |         |         |         |         |        |         |         |         |         |         |         |         |        |   |
| △ [MA]  | △ 2008 1-790-732-81 | & CORD, POWER  |        |        |        |       |        |                       |                       |         |         |         |         |        |         |         |         |         |         |         |         |        |   |
| △ [MA]  | △ 2009 1-824-910-41 | & CORD, POWER  |        |        |        |       |        |                       |                       |         |         |         |         |        |         |         |         |         |         |         |         |        |   |
| △ [MA]  | △ 2010 1-827-947-21 | & CORD, POWER  |        |        |        |       |        |                       |                       |         |         |         |         |        |         |         |         |         |         |         |         |        |   |
| △ [MA]  | △ 2012 1-830-518-21 | & POWER-SUPPLY CORD SET  |        |        |        |       |        |                       |                       |         |         |         |         |        |         |         |         |         |         |         |         |        |   |
| △ [MA]  | △ 2013 1-770-019-61 | & ADAPTOR, CONVERSION PLUG   |        |        |        |       |        |                       |                       |         |         |         |         |        |         |         |         |         |         |         |         |        |   |
| △ [MA]  | △ 2014 8-954-048-93 | & HEADPHONE MDR-Q22LP/S2 SET   |        |        |        |       |        |                       |                       |         |         |         |         |        |         |         |         |         |         |         |         |        |   |
| △ [MA]  | -                   | 2-629-490-01 & Instruction Manual (XP Professional, XP Home Edition) | ●      | ●      | ●      | ●     | ●      | ●                     | ●                     | ●       | ●       | ●       | ●       | ●      | ●       | ●       | ●       | ●       | ●       | ●       | ●       | ●      | ● |
| △ [MA]  | -                   | 2-629-491-01 & Instruction Manual (XP Professional)                  | ●      | ●      | ●      | ●     | ●      | ●                     | ●                     | ●       | ●       | ●       | ●       | ●      | ●       | ●       | ●       | ●       | ●       | ●       | ●       | ●      | ● |
| △ [MA]  | -                   | 2-632-901-11 WELCOME MAT, 3340(U) (D)                                |        |        |        |       |        |                       |                       |         |         |         |         |        |         |         |         |         |         |         |         |        |   |
| △ [MA]  | -                   | 2-632-902-11 LEGAL SAFETY, 3340(U) (D)                               |        |        |        |       |        |                       |                       |         |         |         |         |        |         |         |         |         |         |         |         |        |   |
| △ [MA]  | -                   | 2-633-245-11 SPEC SHEET(3340G)                                       |        |        |        |       |        |                       |                       |         |         |         |         |        |         |         |         |         |         |         |         |        |   |
| △ [MA]  | -                   | 2-633-245-31 SPEC SHEET(3340G)                                       |        |        |        |       |        |                       |                       |         |         |         |         |        |         |         |         |         |         |         |         |        |   |
| △ [MA]  | -                   | 2-633-245-41 SPEC SHEET(3340G)                                       |        |        |        |       |        |                       |                       |         |         |         |         |        |         |         |         |         |         |         |         |        |   |
| △ [MA]  | -                   | 2-631-104-11 TROUBLESHOOTING GUIDE                                   |        |        |        |       |        |                       |                       |         |         |         |         |        |         |         |         |         |         |         |         |        |   |
| △ [MA]  | -                   | 2-631-104-31 TROUBLESHOOTING GUIDE                                   |        |        |        |       |        |                       |                       |         |         |         |         |        |         |         |         |         |         |         |         |        |   |
| △ [MA]  | -                   | 2-631-104-41 TROUBLESHOOTING GUIDE                                   |        |        |        |       |        |                       |                       |         |         |         |         |        |         |         |         |         |         |         |         |        |   |
| △ [MA]  | -                   | 2-633-275-11 SAFETY/REGULATIONS GUIDE 2                              |        |        |        |       |        |                       |                       |         |         |         |         |        |         |         |         |         |         |         |         |        |   |
| △ [MA]  | -                   | 2-633-275-21 SAFETY/REGULATIONS GUIDE 2(D)                           |        |        |        |       |        |                       |                       |         |         |         |         |        |         |         |         |         |         |         |         |        |   |

- This parts list contains two different types of parts. The first type is the parts that are common to all models. The other type is the parts that are different depending on each model.
- As for the T92PSY, check the Product Code in a parenthesis which is written beside the model name, and select the parts to be used. Please refer to the page 4-2 for how to identify the Product Code.
- この部品表は、機種共通の部品と、機種によって使い分けが必要な部品に分かれています。
- T92PSYは機種名の横に記載されている、括弧内のProduct Codeを確認してから、使用する部品を選択してください。Product Codeの確認方法は4-2ページを参照してください。

# CHAPTER 5.

## OTHER

### 5-1. The Barcode Label

The hatched portion of the barcode is used as the repair data.

バーコードラベルの網掛け部は、修理データとして使用いたします。

[MBX-120 Board]  
(Side A)

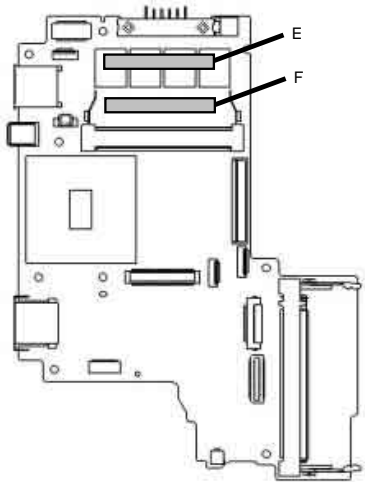

[LCD Unit]  
(Rear)



[Drive]  
(Rear)

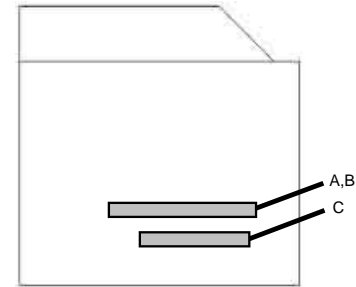

[MBX-120 Board]  
(Side B)

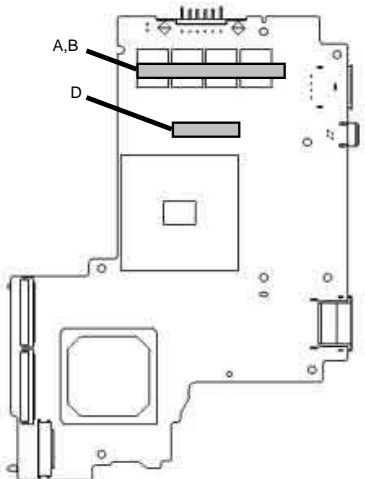

[Keyboard Unit]  
(Rear)

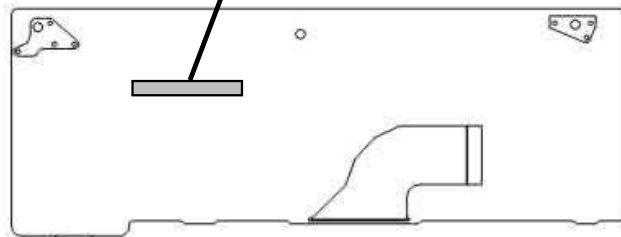

[HDD (TOSHIBA)]  
(Top)

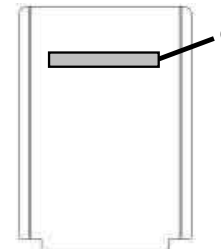

[BRACKET (HDDTO)]  
(Top)

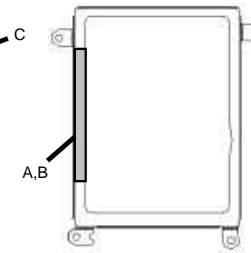

[HDD (HITACHI)]  
(Top)

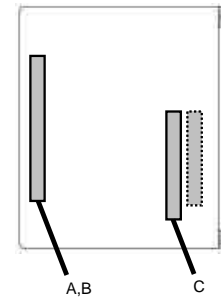

[MODEM Card]

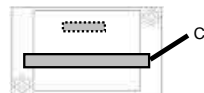

[W-LAN Card]

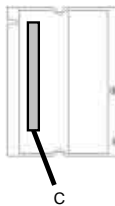

A : Part No.  
B : Serial No.  
C : Maker Barcode  
D : Revision No.  
E : Global User ID (iLink)  
F : Mac Address

**Confidential**

VGN-T52B/T72B/T72PZ/T92PS/T92PSY/T92S (J)  
VGN-T330FP/T340P/T350/T350P/T360P/T370P (AM)  
VGN-T36SP/T37C/T37GP/T37TP (AO)

## 5-2. Precautions for Handling the Drive

In performing a repair, observe the following precautions.

修理の際には以下の注意事項を厳守してください。

① Do not turn the power switch on until the palmrest and the keyboard are installed completely.

① パームレストやキーボードを**完全に**取り付けるまでは電源を入れないでください。

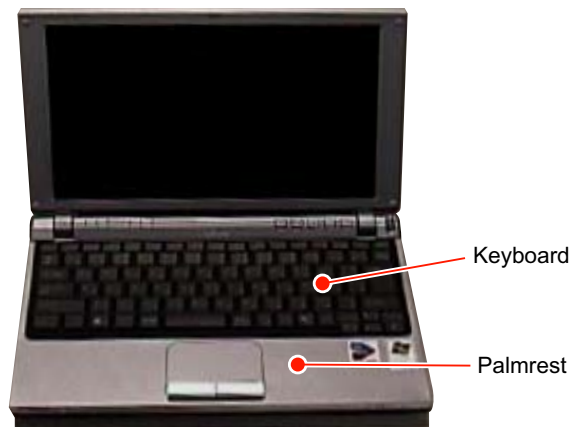

② If the power switch is to be turned on with the set in disassembled state, be sure to load a dummy disc in the drive.

② 分解した状態で電源を入れる必要がある場合には**“必ず”**ダミーのDiscをドライブにセットしておいてください。

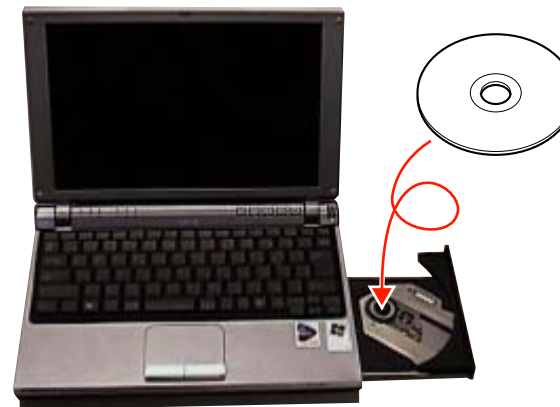

③ If the power switch is to be turned on with the set in disassembled state for checking the drive condition, be sure to turn the power switch on with the tray drawn out.

③ 分解した状態で電源を入れ、ドライブの状態を確認する必要がある場合には**“必ず”**トレイを引き出した状態で電源を入れてください。

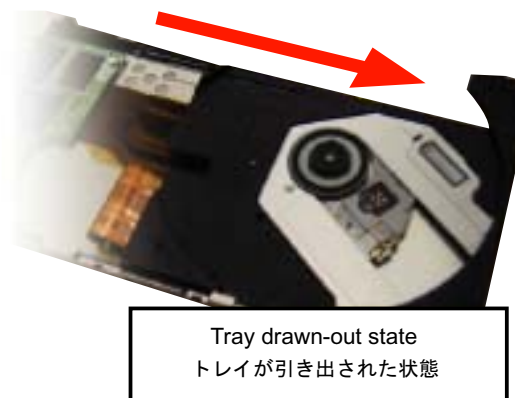

Confidential

VGN-T52B/T72B/T72PZ/T92PS/T92PSY/T92S (J)  
VGN-T330FP/T340P/T350/T350P/T360P/T370P (AM)  
VGN-T36SP/T37C/T37GP/T37TP (AO)

### 5-3. Note for WWAN Board Replacement

#### 5-3. WWAN 基板交換時の注意

When replacing the WWAN Board (Ref.581 A-1132-387-A GPRS UNIT (S)), change the barcode label on the bottom.

WWAN基板(Ref. 581 A-1132-387-A GPRS UNIT (S))を交換した際にはボトムのパターンラベル貼り替え作業を行ってください。

- ① Peel off the barcode label which is attached to the bottom. (Refer to the figure below.)
- ① ボトムに貼られているパターラベルをはがします。(下図参照)

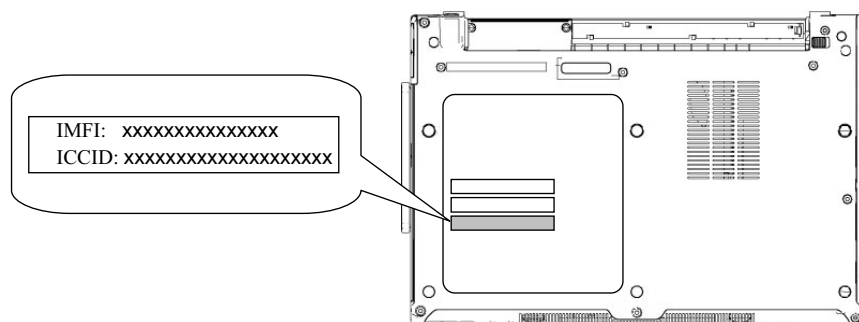

- ② Attach the barcode label which is included with the WWAN Board to the position where you peeled off the label in the step (1).
- ② WWAN基板に同梱されているパターラベルを①ではがした位置に貼ってください。



\*There is no problem though the ICCID is not printed on the substituted barcode label.

\*貼り替えたパターラベルにはICCIDが印刷されていませんが問題ありません。



VGN-T52B/T72B/T72PZ/T92PS/T92PSY/T92S (J)  
 VGN-T330FP/T340P/T350/T350P/T360P/T370P (AM)  
 VGN-T36SP/T37C/T37GP/T37TP (AO)

List of VGN-T Series (As of July, 2005)

| Service Manual Part No. | Model Name  |              |             |   |
|-------------------------|-------------|--------------|-------------|---|
|                         | J           | AM           | EU          | AO  |
| 9-876-390-XX            | VGN-T30B/L  | VGN-T130FP/L | VGN-T1XP/L  | VGN-T15C/S  |
|                         | VGN-T30B/T  | VGN-T140/L   | VGN-T1XP/T  | VGN-T15C/T  |
|                         | VGN-T50B/L  | VGN-T140P/L  |             | VGN-T16GP/S   |
|                         | VGN-T50B/T  | VGN-T150/L   |             | VGN-T16LP/S   |
|                         | VGN-T50PZ   | VGN-T150P/L  |             | VGN-T16SP/S   |
|                         | VGN-T70B/L  | VGN-T150P/T  |             | VGN-T17C/S  |
|                         | VGN-T90PS*  | VGN-T160P/L  |             | VGN-T17GP/S   |
|                         | VGN-T90S*   | VGN-T170P/L  |             | VGN-T17GP/T   |
| 9-876-404-XX            | VGN-T51B/L  | VGN-T240P/L  | VGN-T2XP/L  | VGN-T16RLPS   |
|                         | VGN-T71B/L  | VGN-T250/L   | VGN-T2XP/S  | VGN-T26C/L  |
|                         | VGN-T71B/T  | VGN-T250P/L  | VGN-T2XRP/S | VGN-T26C/S  |
|                         | VGN-T91PS*  | VGN-T250P/S  |             | VGN-T26C/T  |
|                         | VGN-T91PSY* | VGN-T260P/L  |             | VGN-T26SP/S   |
|                         | VGN-T91S*   | VGN-T270P/L  |             | VGN-T27C/L  |
|                         |             |              |             | VGN-T27GP/L   |
|                         |             |              |             | VGN-T27GP/S   |
|                         |             |              |             | VGN-T27LP/L   |
|                         |             |              |             | VGN-T27LP/S   |
|                         |             |              |             | VGN-T27TP/L   |
|                         |             |              |             | VGN-T27TP/S   |
| 9-876-418-XX            | VGN-T52B/L  | VGN-T330FP/L |             | VGN-T36SP/S   |
|                         | VGN-T72B/L  | VGN-T330FP/T |             | VGN-T37C/L   |
|                         | VGN-T72B/T  | VGN-T340P/L  |             | VGN-T37GP/L   |
|                         | VGN-T72PZ   | VGN-T350/L   |             | VGN-T37GP/S   |
|                         | VGN-T92PS*  | VGN-T350P/L  |             | VGN-T37TP/L  |
|                         | VGN-T92PSY* | VGN-T350P/S  |             | VGN-T37TP/S  |
|                         | VGN-T92S*   | VGN-T350P/T  |             |   |
|                         |             | VGN-T360P/L  |             |   |
|                         | VGN-T370P/L |              |             |   |

\* : CTO Model

 : Additional Models

This manual and the constituent data may not be replicated, copied nor reprinted in whole or in part without prior written authorization of Sony Corporation.

本マニュアルの一部、または全部について、無断でデータの複製、複写、転載することを禁じます。

## Revision History

| Suffix    | Ver.   | Date       | Contents  | QM No.      |
|-----------|--------|------------|---|-------------|
| - 01      | Ver. 1 | 2005.05.13 | First Edition   |             |
| - 02      | Ver. 2 | 2005.05.30 | △ Front Page (Model Lineup), Page 1-1, Page 2-1, Page 3-1 to 3-2, Page 4-1, Page 4-3 to 4-4, Page 4-6 to 4-13, Page 5-3, Back Cover | N2005_012AK |
| - 03      | Ver. 3 | 2005.06.09 | △ Front Page (Model Lineup), Page 1-2, Page 4-1, Page 4-4, Page 4-6, Page 4-8, Page 4-10, Page 4-12 to 4-13, Back Cover             | N2005_023AK |
| - 04      | Ver. 4 | 2005.07.07 | △ Front Page (Model Lineup), Page 1-2, Page 4-1, Page 4-4, Page 4-6, Page 4-8, Page 4-10, Page 4-12 to 4-13, Back Cover             | N2005_036AK |
| <Remarks> |        |            |   |             |